

## APPLICATION NOTE

# Contactless Angle Measurement using KMZ41 and UZZ9000

AN98097



Abstract

*Angle measurement is frequently required in both automotive and industrial applications. Contactless methods have the advantage that they are free of wear. If a magnetic field acts as the transmitter between the physical value to be measured and the actual sensor, the magnetic system and the signal conditioning electronics can be encapsulated separately making such systems robust against dirt, dust and liquid as well as mechanical destruction. Among this class of measurement systems, those using the magnetoresistive effect (MR effect) are characterised by the additional feature that they evaluate the direction of the magnetic field and not the field strength. Therefore MR based systems tolerate variations in field strength caused by ageing or temperature-sensitivity of the magnet as well as mechanical tolerances. This recommends MR based systems for applications where robust, precise, and also cost-efficient solutions are required.*

*Philips Semiconductors provides a two-chip solution for an application-specific MR angle measurement system. It consists of the magnetoresistive sensor KMZ41 and the sensor signal conditioning IC UZZ9000. The UZZ9000 was designed for the usage with the KMZ41 and therefore provides an optimised interface to this sensor. It can also be used in conjunction with other sensors providing two sinusoidal output signals with a 90°-phase shift.*

© Philips Electronics N.V. 1998

All rights are reserved. Reproduction in whole or in part is prohibited without the prior written consent of the copy-right owner.

The information presented in this document does not form part of any quotation or contract, is believed to be accurate and reliable and may be changed without notice. No liability will be accepted by the publisher for any consequence of its use. Publication thereof does not convey nor imply any license under patent- or other industrial or intellectual property rights.

**APPLICATION NOTE**

**Contactless Angle Measurement using  
KMZ41 and UZZ9000**

**AN98097**

**Author(s):**

**Klaus Dietmayer  
Systems Laboratory Hamburg,  
Germany**

**Keywords**

UZZ9000

KMZ41

Contactless Angle Measurement

Magnetoresistive Sensors

Date: 16 December 1998

### Summary

This report describes how to build a MR based measurement system using the magnetoresistive sensor KMZ41 and the sensor signal conditioning IC UZZ9000 available from Philips Semiconductors.

The first section gives an introduction into MR technology. It is shown that the magnetoresistive effect is naturally an angular effect recommending its use for angle measurement applications. The next sections describe the basic function of a system consisting of the sensor KMZ41 and the sensor signal conditioning IC UZZ9000. The KMZ41 sensor comprises two Wheatstone bridges on one substrate. This gives a very good matching of mechanical and electrical properties. The signal conditioning IC UZZ9000 is optimised for the usage with the KMZ41 but can also be used in conjunction with any other sensor providing two sinusoidal signals with 90°-phase shift, such as resolver applications, Hall sensors and GMR sensor. This mixed signal IC provides an analog, ratiometric output signal that allows a direct replacement of present potentiometer solutions. The input angular range can be adjusted between 0° to 30° and 0° to 180° in steps of 10°. Also, the zero point of the mechanical angle is user programmable between +/- 5° in steps of 0.5°. Both KMZ41 and UZZ9000 are specified between -40°C to +150°C for normal operation.

The last section describes the non-ideal cases and their impact on system accuracy. The error analysis based on a 3-Sigma confidence interval shows that the absolute accuracy is better than 0.6° in a temperature range from -40°C to +85°C. This corresponds to a relative error better than 0.4% referred to 180° full scale. At 150°C, the maximum absolute error is better than 1.2°. The resolution of the measurement system is better than 0.1° at all temperatures. If a field strength of 100 kA/m (1250 Gauss) is used for the magnetic system, then the hysteresis lies within the resolution and is therefore not measurable.

# Contactless Angle Measurement Using KMZ41 and UZZ9000

Application  
Note AN98097

## Contents

<b>1. INTRODUCTION.....</b>	<b>7</b>
<b>2. MAGNETORESISTIVE SENSOR TECHNOLOGY FOR ANGLE MEASUREMENT.....</b>	<b>9</b>
<b>3. SYSTEM OVERVIEW .....</b>	<b>12</b>
<b>4. SENSOR KMZ41 .....</b>	<b>14</b>
4.1 LAYOUT OF THE KMZ41 SENSOR.....	14
4.2 INPUT AND OUTPUT SIGNALS .....	14
4.3 MAGNETS AND MAGNET ARRANGEMENTS .....	16
4.4 OTHER MECHANICAL SET-UPS .....	17
<b>5. SIGNAL CONDITIONING IC UZZ9000.....</b>	<b>19</b>
5.1 GENERAL DESCRIPTION.....	19
5.2 CHARACTERISTICS OF INPUT AND OUTPUT SIGNALS.....	22
5.3 ADJUSTING THE ANGULAR RANGE AND THE ZERO POINT OFFSET .....	24
5.3.1 Changes of the Output Curve Characteristic.....	24
5.3.2 How to Set a Certain Angular Range .....	25
5.3.3 How to Set a Zero Point Offset.....	26
5.4 OFFSET TRIMMING.....	27
5.4.1 Trim Interface .....	28
5.4.2 How to Enter the Trim Mode .....	29
5.4.3 Offset Calibration.....	29
5.5 RESET .....	32
5.6 DIAGNOSTIC.....	33
5.7 MEASUREMENTS DYNAMICS.....	33
<b>6. SCHEMATICS FOR CONNECTING KMZ41 AND UZZ9000.....</b>	<b>35</b>
6.1 SINGLE MEASUREMENT SYSTEM .....	35
6.2 FAULT TOLERANT SYSTEMS.....	36
6.3 TYPICAL APPLICATION CIRCUIT .....	38
<b>7. SYSTEM ACCURACY .....</b>	<b>39</b>
7.1 SENSOR KMZ41 .....	39
7.1.1 Less Magnetic Field Strength.....	39
7.1.2 Effects of Inhomogeneous Magnetic Fields .....	42
7.1.3 Non-Ideal Properties of the Components .....	43
Offset and Offset Drift .....	43
Different Signal Amplitudes.....	45
Phase Difference between Channels.....	46
7.1.4 DISCUSSION OF DIFFERENT EFFECTS.....	47
7.2 SIGNAL CONDITIONING IC UZZ9000 .....	47
Example: .....	48
7.3 APPLICATION EXAMPLE FOR ERROR CALCULATION .....	48
<b>8. REFERENCES.....</b>	<b>52</b>

---

**Contactless Angle Measurement Using  
KMZ41 and UZZ9000**

**Application  
Note AN98097**

---

## 1. INTRODUCTION

Magnetoresistive sensors (MR sensors) of Philips Semiconductors make use of the fact that the electrical resistance of certain ferromagnetic alloys, such as permalloy, is influenced by external magnetic fields. This solid state magnetoresistive effect - or anisotropic magnetoresistance (AMR) - is easily realised in thin film technology, allowing the production of precise but also cost-effective sensors.

As the magnetoresistive effect is naturally an angular effect, its utilization for contactless angle measurement systems fits perfectly. The underlying principle is simple: the electrical resistance of the permalloy strip changes with the angle between the internal magnetization vector in the strip and the vector of electrical current flowing through it. Consequently, to achieve accurate measurements, the only condition to be met is that the internal magnetization vector of the permalloy must directly follow an external magnetic field vector. This is ensured when using an external field strength much higher than the internal magnetization. As this strong external field saturates the sensor, the actual field strength has no impact on the measurements. Only the direction of the field is evaluated. This leads to the following advantages of magnetoresistive angle measurement systems:

- Independence of magnetic drift during life time.
- Independence of magnetic drift with temperature.
- Independence of mechanical assembly tolerances.
- Independence of mechanical shifts caused by thermal stress.

Moreover, the small offset drift of the sensor signals requires no compensation for temperature effects, which simplifies implementation.

Additionally, MR based systems show the same advantages as all other contactless measurement systems; they are free of wear and they can be completely encapsulated making the sensor modules robust regarding contamination and mechanical destruction. All these advantages recommend magnetoresistive angle measurement systems for applications requiring very robust and precise but also cost-effective solutions. This, for example, is the case in all automotive applications.

To support users who want to build up a contactless angle measurement system, Philips Semiconductors provides a two-chip solution consisting of the magnetoresistive sensor KMZ41 and the sensor signal conditioning IC UZZ9000. The UZZ9000 was designed for the usage with the KMZ41 and therefore provides an optimised interface to this sensor. It has a standard analog output that operates ratiometrically with respect to supply voltage. Consequently, this two-chip system may directly replace present potentiometer solutions.

The intention of this paper is to provide the necessary background information for system design. After giving a short introduction in the MR technology for angle measurement and discussing basics of possible system set-ups, both the KMZ41 and the UZZ9000 are described in more detail. Besides electrical characteristics and functional behaviour, main items are the correct choice of the magnet

---

**Contactless Angle Measurement using  
KMZ41 and UZZ9000**

**Application  
Note AN98097**

---

arrangement and the trimming procedure to compensate the static offsets of the sensor. The last section describes non-ideal cases and their impact on system accuracy. A proposal is made how to calculate the achievable system accuracy under different system constraints.



## 2. MAGNETORESISTIVE SENSOR TECHNOLOGY FOR ANGLE MEASUREMENT

Magnetoresistive (MR) sensors make use of the magnetoresistive effect, the property of a current carrying magnetic material to change its resistance in the presence of an external magnetic field.

Figure 1 shows a strip of ferromagnetic material, called permalloy.

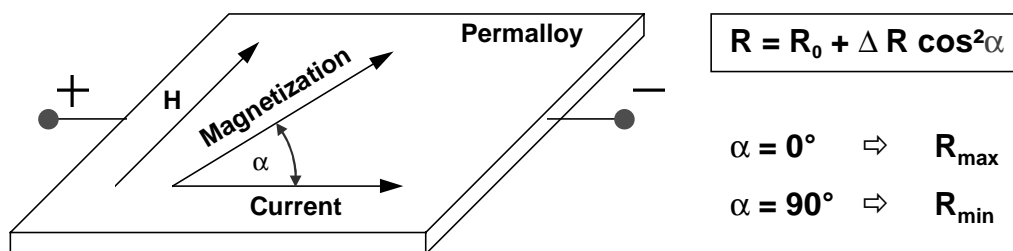

Figure 1: The magnetoresistive effect in permalloy

Assume that, when no external magnetic field is present, the permalloy has an internal magnetization vector  $M$  parallel to the current flow ( $\alpha = 0$ ). If an external magnetic field  $H$  is applied, parallel to the plane of the permalloy but perpendicular to the current flow, the internal magnetization vector of the permalloy will rotate around an angle  $\alpha$ . As a result, the resistance  $R$  of the permalloy will change as a function of the rotation angle  $\alpha$ , as given by:

$$R = R_0 + \Delta R_0 \cos^2 \alpha \quad (1)$$

$R_0$  and  $\Delta R_0$  are material constants. To achieve an optimum sensor characteristics, Philips use Ni19Fe81, which has a high  $R_0$  value and low magnetostriction. With this material,  $\Delta R_0$  is in the order of 2 to 3%. It is obvious from this quadratic equation that the resistance to magnetic field relation is non-linear. It becomes also clear that the magnetoresistive effect is naturally an angular effect recommending its utilisation for angle measurement applications. Here the external magnetic field carries the measurement information between sensor and physical value to be measured.

Having this principle of operation in mind, it becomes clear that the precondition to achieve accurate measurements is that the internal magnetization vector  $M$  must directly follow the vector  $H$  of the external field. This can be achieved by applying an external field  $H$  much higher than the internal field of approximately 3 kA/m. When using the KMZ41 for angle measurement, it is recommended to provide an external field of at least

$$H \geq 100 \text{ kA / m (1250 Gauss)}. \quad (2)$$

# Contactless Angle Measurement using KMZ41 and UZZ9000

# Application Note AN98097

In that case the two vectors  $M$  and  $H$  are virtually parallel to each other.

Normally, the external magnetic field is generated by permanent magnets, e.g. SmCo types. Figure 2 shows a basic set-up, where the angular position of a rotating shaft is measured with the help of the permanent magnet fixed to it.

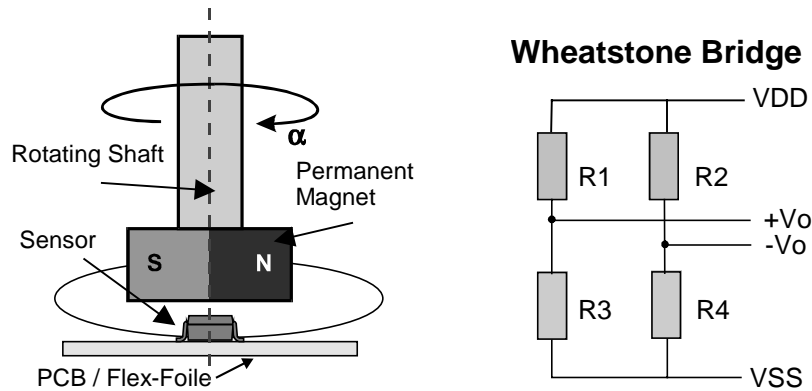

Figure 2 Basic arrangement of sensor and magnet for contactless angle measurement.

The magnetoresistive angle sensors of Philips Semiconductors are etched on a silicon substrate, with four permalloy strips arranged in a Wheatstone bridge configuration. According to the basic relationship given by Equation (1), the differential output signal ( $+V_o$ ,  $-V_o$ ) of such a Wheatstone bridge is proportional to  $\sin 2\alpha$ . This means that a sensor comprising one Wheatstone bridge can measure an angular range of  $90^\circ$ . This is visualised in Figure 3.

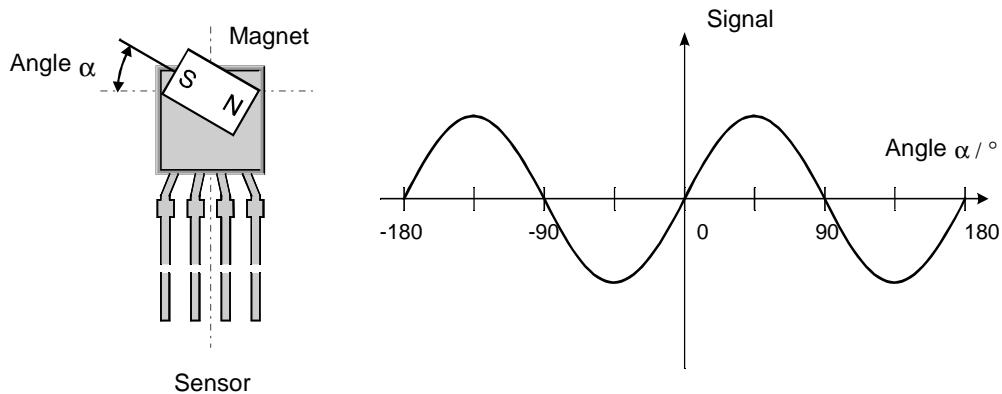

Figure 3: Output signal from a single Wheatstone bridge sensor

Apart from the limited angular range, the single bridge sensor shows another disadvantage regarding signal evaluation. As the signal amplitude changes with temperature, the output signal of the sensor forces the user to implement a temperature compensation. This is avoided when using a two-bridge arrangement combined with a signal evaluation explained below. Figure 4 shows the principle.

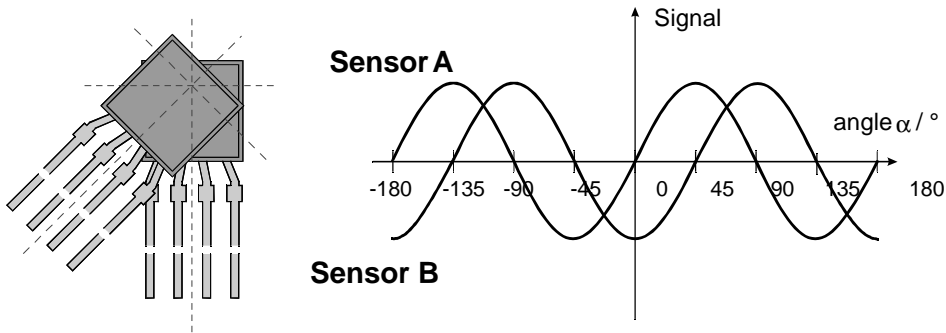

Figure 4 Output signal from a double Wheatstone bridge sensor (KMZ41)

The two sensor bridges are positioned at an offset angle of  $45^\circ$  to each other. In this arrangement, the two output signals show an electrical phase shift of  $90^\circ$ . The two signals are therefore proportional to  $\sin 2\alpha$  and  $\cos 2\alpha$ , respectively. It can be proved easily that these two signals now allow an evaluation of a  $180^\circ$  angular range.

Even in this arrangement, the signal amplitudes will change with temperature. However, both bridges are processed in the same thin film process steps on the same substrate and they will therefore show very similar characteristic. Assuming that both output signals have no offsets or offsets have been compensated previously, the output signals can be described mathematically as follows:

$$X(\alpha, T) = X_0(T) \sin 2\alpha \quad (3)$$

$$Y(\alpha, T) = Y_0(T) \cos 2\alpha \quad (4)$$

Assuming further that the amplitudes of both signals are really identical ( $X_0 = Y_0$ ), the unknown angle  $\alpha$  can be determined without any error from the signals  $X$  and  $Y$  as given by Equation (5):

$$\alpha = \frac{1}{2} \arctan\left(\frac{X}{Y}\right) \quad (5)$$

This result does not depend on the absolute amplitude of the signals. Consequently, temperature measurement and compensation of the temperature effects is not required.

Of course, due to the non-ideal manufacturing process, a real sensor will not show the ideal behaviour assumed above. A detailed discussion of these non-ideal cases and their impact on system accuracy can be found in section 7.

## 3. SYSTEM OVERVIEW

An angle measurement system requires one sensor KMZ41 and one sensor signal evaluation IC UZZ9000. Figure 5 shows the block diagrams of both components:

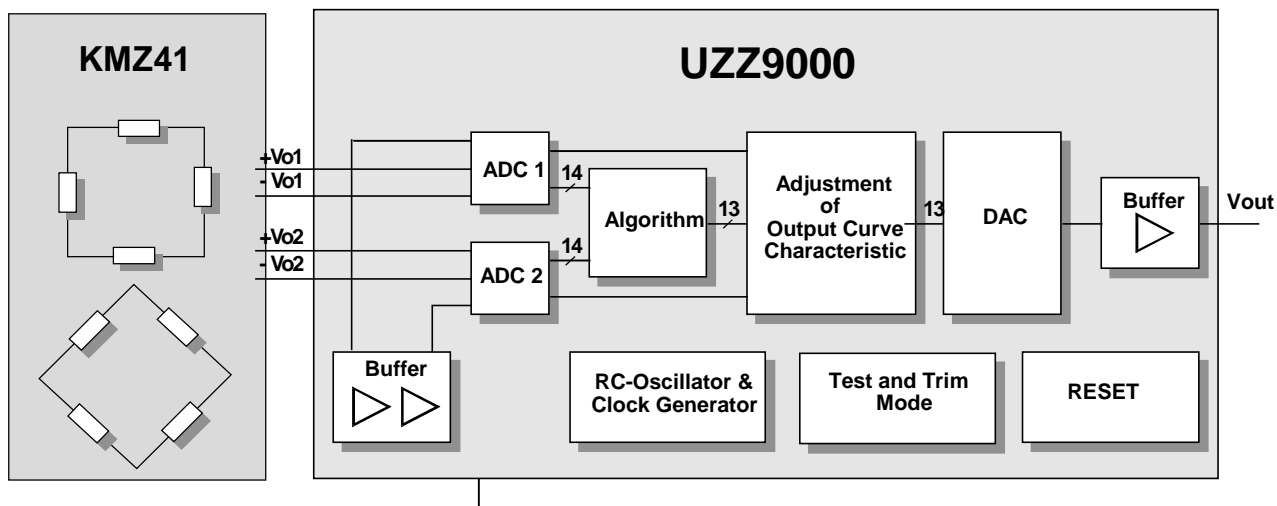

Figure 5: Block diagram of the two-chip measurement system

The differential sensor signals  $\pm Vo1$  and  $\pm Vo2$  of the KMZ41 are sampled by the UZZ9000 input stage and then are converted into the digital domain. This conversion is done with the help of two separate but simultaneously clocked Sigma-Delta AD converter (4). The digital representations of the two signals are then used to calculate the angle. For this calculation the CORDIC algorithm is used. CORDIC is nothing else than an iterative way to calculate the inverse tangent function of both signals without extensive numerical overhead. Details of the CORDIC algorithm can be found in reference (3).

Afterwards, the current angle represented as a 13-bit digital value is converted back into the analog domain. The output characteristic of the DA converter is shown in Figure 6. This DA converter, as well as the ADCs in the input stage, operates ratiometric to the analog supply voltage ( $VDDA$ ,  $VSSA$ ). This means that all analog signals are represented as a fraction of this analog supply voltage. **Note that due to this ratiometric operation, the same analog voltage as used for the UZZ9000 must supply the KMZ41 sensor.** This guarantees that variations of the supply voltage will have no impact on system accuracy.

As can be seen from Figure 6, the mechanical angular range is linearly converted into analog voltages between 5.5% and 94.5%  $VDDA$ . This output voltage range represents the normal operation mode. Below and above this valid range lie diagnostic areas. The output signal enters these areas only in cases of errors. An error condition occurs due to a shortcircuit of the output  $VOUT$  to the supply voltage or ground, or if the magnet has been lost and no valid input signals are available.

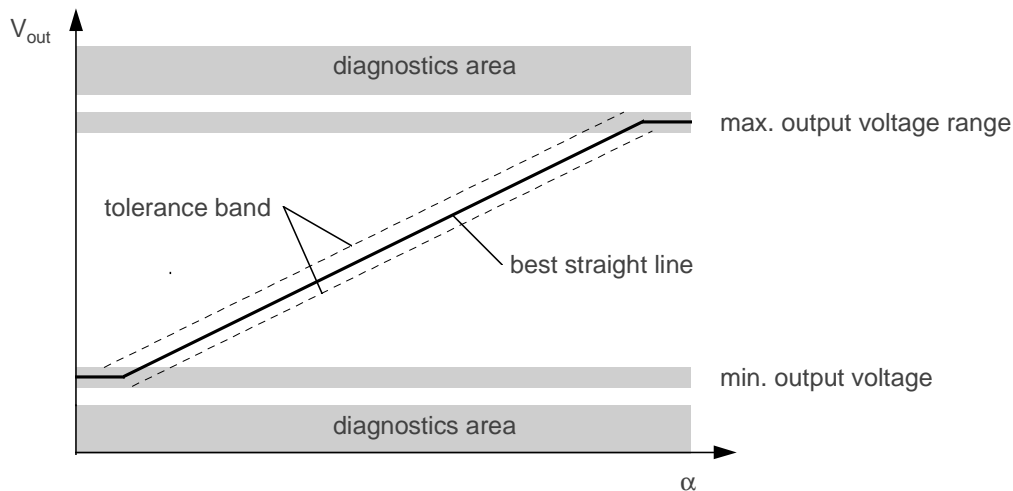

Figure 6: UZZ9000 output characteristic

To adapt the UZZ9000 to different application requirements, the mechanical input angular range can be adjusted between  $0^\circ$  to  $30^\circ$  and  $0^\circ$  to  $180^\circ$  in steps of  $10^\circ$ . This function adapts the fixed output voltage range to the different possible input ranges to reduce the absolute angular error of the DAC and thus the overall system error. Moreover, even the zero point of the output curve can be adjusted in the range of  $\pm 5^\circ$  to compensate for tolerances. Both settings are derived from an analog voltage the user must provide at special pins of the UZZ9000 during reset. Details on how to adjust the UZZ9000 to different angular ranges and zero point offsets can be found in section 5

As mentioned before, the sinusoidal input signals coming from the KMZ41 may have a static offset that must be compensated to get accurate results. This compensation is done separately for each channel by providing an analog voltage to special pins of the UZZ9000. These voltages (OFF1, OFF2) must be provided continuously during operation as compensation is done real time and not stored at system start. As KMZ41 and UZZ9000 are not sold as one unit, the user is responsible for providing the correct compensation voltages. Due to the ratiometric nature, the offset voltages must be referenced from the same analog voltage  $V_{DDA}$ , for example, using a laser trimmable resistor divider. The UZZ9000 provides some special functions for the trimming process, which are described in section 5.

Apart from the features described above, the UZZ9000 provides an on-chip RC-Oscillator generating the clock for the IC's state machine. Consequently, no external clock reference is required for system operation. Moreover, the UZZ9000 has a power-down and power-up reset with build-in hysteresis. This reset block automatically generates a reset signal during power-on or if the save voltage range is left.

## 4. SENSOR KMZ41

The magnetoresistive sensor KMZ41 of Philips Semiconductors has been designed for angle measurement applications, preferably in combination with the signal conditioning IC UZZ9000. The application relevant items are discussed in the following sections. The KMZ41 properties affecting the system accuracy are discussed in section 7. Please refer to the latest data sheet to get actual specification data of the KMZ41.

### 4.1 Layout of the KMZ41 Sensor

The KMZ41 comprises two complete Wheatstone bridges made on the same substrate in thin film technology. Therefore both bridges show a very good matching regarding electrical and mechanical properties. Figure 7 shows the layout of the sensor.

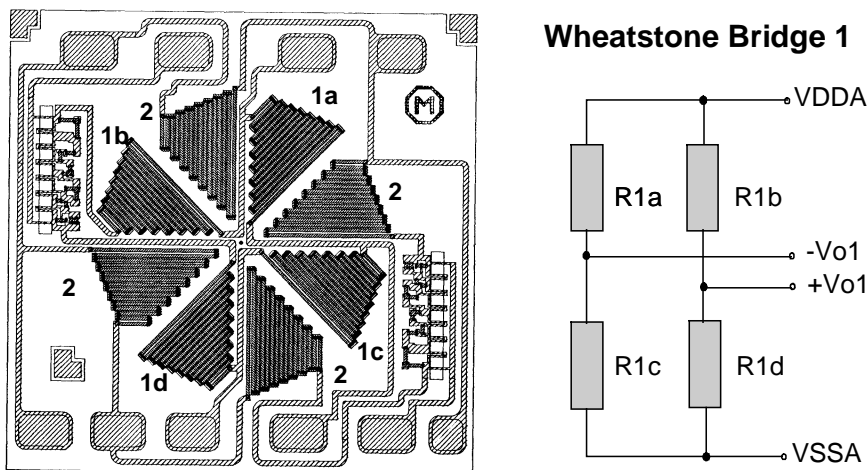

Figure 7: Layout of the double bridge sensor KMZ41.  
1a to 1d indicate the sensitive elements of Wheatstone bridge 1

Moreover, the different sensitive elements of Wheatstone bridge 1 are marked. Both bridges have separate connections for supply voltage. The die size of the KMZ41 is about  $1.5 \text{ mm}^2$  with a sensitive area of about  $1 \text{ mm}^2$ .

In order not to influence the external magnetic field and therefore the accuracy of measurements, the lead frame of the KMZ41 is made without use of ferrous material. **Please note that with respect to a good system design it is also important not to place elements consisting of ferrous material very close to the KMZ41.**

### 4.2 Input and Output Signals

The KMZ41 is housed in a SO8 package. The pinning is given in TABLE 1.

**TABLE 1: Pinning of the KMZ41**

Pin	Symbol	Type*	Description
1	-Vo1	A	negative output voltage of bridge 1
2	-Vo2	A	negative output voltage of bridge 2
3	Vcc2	A	supply voltage bridge 2
4	Vcc1	A	supply voltage bridge 1
5	+Vo1	A	positive output voltage of bridge 1
6	+Vo2	A	positive output voltage of bridge 2
7	GND2	A	Ground bridge 2
8	GND1	A	Ground bridge 1

\* A = analog pin, D = digital pin

Apart from the two separate supplies, the KMZ41 provides two differential signal lines for each Wheatstone bridge. The following discussion assumes that the external magnetic field is strong enough to saturate the sensor. This ensures that each bridge of the KMZ41 has a sinusoidal output voltage as given in Figure 8.

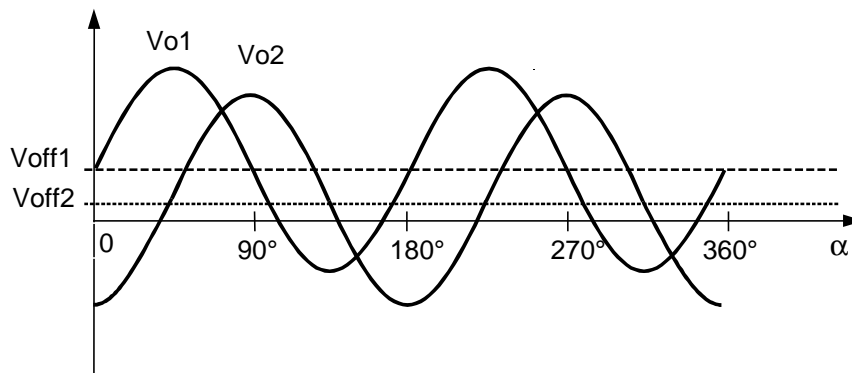

Figure 8: Output signals of the KMZ41

Ideally, these signals would have no static DC offset. However, static offsets cannot be completely avoided due to manufacturing tolerances. As these DC-offsets  $V_{off1}$  and  $V_{off2}$  affect the system accuracy, they must be compensated by the signal conditioning IC. The UZZ9000 provides special build-in functions for this task. Please note that Figure 8 is drawn exaggerated to emphasize the effect, the actual sensor has much smaller offsets.

The amplitudes of the output signals depend on both the supply voltage and the ambient temperature. Because of the ideal thermal coupling, the temperature coefficients of both bridges are almost identical. The MR effect exhibits a negative temperature coefficient. This means that with higher temperatures, the signal amplitude decreases and vice versa. A short example demonstrates this effect:

The typical temperature coefficient (TCV<sub>peak</sub>) for the KMZ41 is -0.31 % / K. Consequently, based on a known peak voltage at room temperature, the peak voltage at any other temperature T can be calculated as follows:

$$V_{peak_T} = V_{peak_{25^\circ C}} * \left( 1 + (T - 25^\circ C) * \frac{TCV_o}{100\%} \right) \quad (6)$$

To give an example, the peak voltage of the KMZ41 at room temperature and 5V supply is typically  $V_{peak_{25^\circ C}} = 78$  mV. Consequently, at  $T = 125^\circ C$ , a peak voltage of  $V_{peak_{125^\circ C}} = 53.8$  mV can be expected. At  $-40^\circ C$ , however, the peak voltage increases to  $V_{peak_{-40^\circ C}} = 93.7$  mV. This effect does not affect the system accuracy when using the signal processing implemented in the UZZ9000.

Besides the signal amplitude, also the DC offset drifts with temperature. However, this offset drift is so small that it needs no compensation in normal applications. The offset drift and its impact on system accuracy is discussed in section 7.

### 4.3 Magnets and Magnet Arrangements

It is recommended to use the KMZ41 in a magnetic field saturating the sensor. This is guaranteed when the field strength is above 100 kA/m in the sensitive area of the sensor.

The most simple magnet arrangement is that of a block magnet rotating directly above the KMZ41 as depicted in Figure 2. The effective magnetic field strength of such a block magnet arrangement depends on the distance between magnet and sensor, magnet size and magnet material. Because of strong field requirements, the usage of rare earth magnets such as SmCo or NeFeB is recommended.

Figure 9 shows the field strength of three sample magnets as a function of the distance between magnet and the top of the sensor package. It becomes clear that only the SmCo type achieves field strengths of 100 kA/m and more for distances below 0.8 mm. Its dimension of 8x3x7.5 has been chosen due to economic aspects and is used in several applications. Stronger fields allowing larger distances, this can be achieved easily when using thicker but more expensive magnets, e.g. a SmCo 8x4x7.5. Please note that the underlined dimension characterises the direction of magnetization.

In low-end applications, however, a low system price may be more important than excellent system accuracy. As a consequence, here it may be adequate to use cheaper magnets not saturating the sensor, e.g. FXD types. The additional error induced by this measure is discussed in section 7.



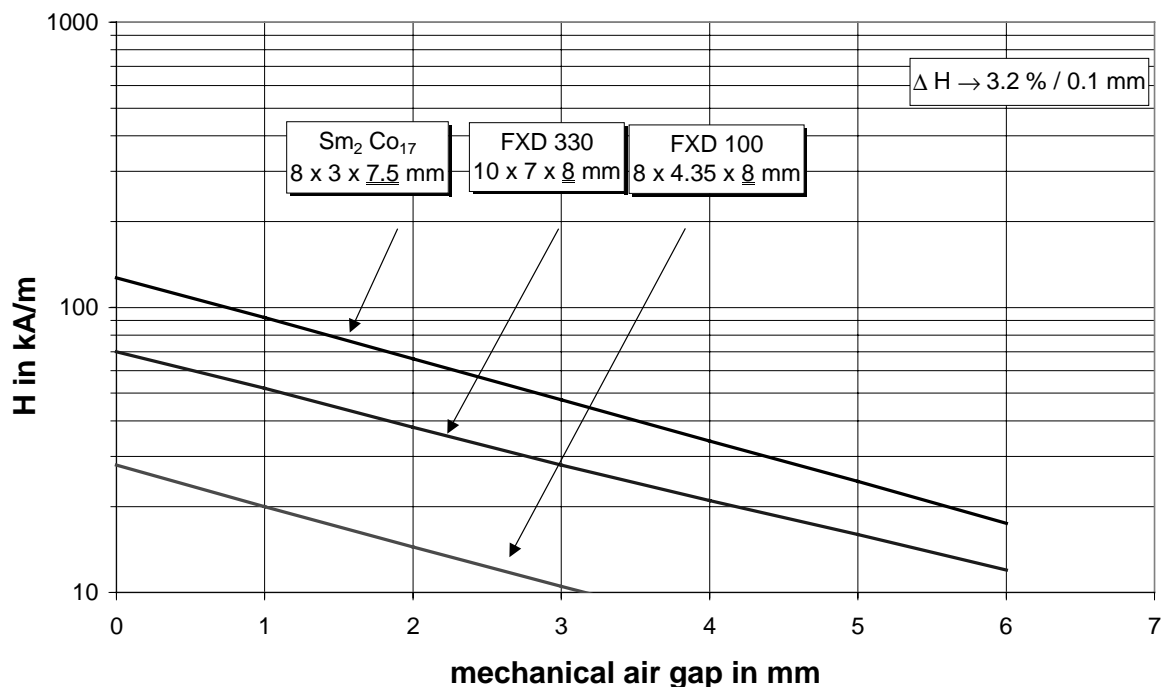

Figure 9: Field strength in the sensitive plane of the KMZ41 in dependence of the air gap between the top of the sensor package and the block magnet. The underlined dimension characterises the direction of magnetization.

#### 4.4 Other Mechanical Set-ups

The usage of a block magnet rotating above the sensor is only one simple possibility for a magnetic system set-up. Meanwhile, several application specific solutions were built. These set-ups use flux rings and flux guides. The targets of optimisation are:

- Concentration of the magnetic field in order to allow the usage of weaker magnets.
- Making the magnetic field homogenous in a wider range to tolerate larger mounting tolerances.
- Shielding of the primary field against external fields.

Figure 10 shows the general arrangement of such a magnetic system. The inner walls of the flux ring carry the permanent magnets. This unit rotates around the fixed sensor. Such a magnet arrangement (diameters, dimensions of the flux ring and the magnets) must be dimensioned application-specific. A final solution will be a compromise between system accuracy and system costs.

# Contactless Angle Measurement using KMZ41 and UZZ9000

# Application Note AN98097

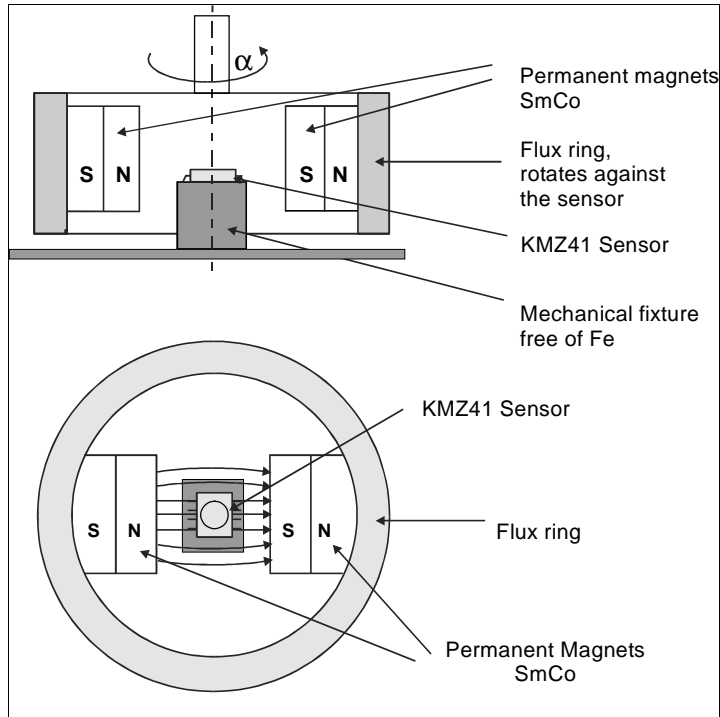

Figure 10: Mechanical set-up using a flux ring for shielding against external fields and 2 permanent magnets generating a homogenous field inside the ring

## 5. SIGNAL CONDITIONING IC UZZ9000

The UZZ9000 is a mixed signal IC for angle calculation. It combines two sinusoidal signals (sine and cosine) into one single linear output signal. The UZZ9000 can be used in conjunction with any sensor that encodes a mechanical angle into two sinusoidal signals with 90° phase shift.

### 5.1 General Description

The basic operation of the UZZ9000 has already been described in section 3. Within this section, some more details should be addressed that might be useful for a system designer. The detailed block diagram of the UZZ9000 is given in Figure 11.

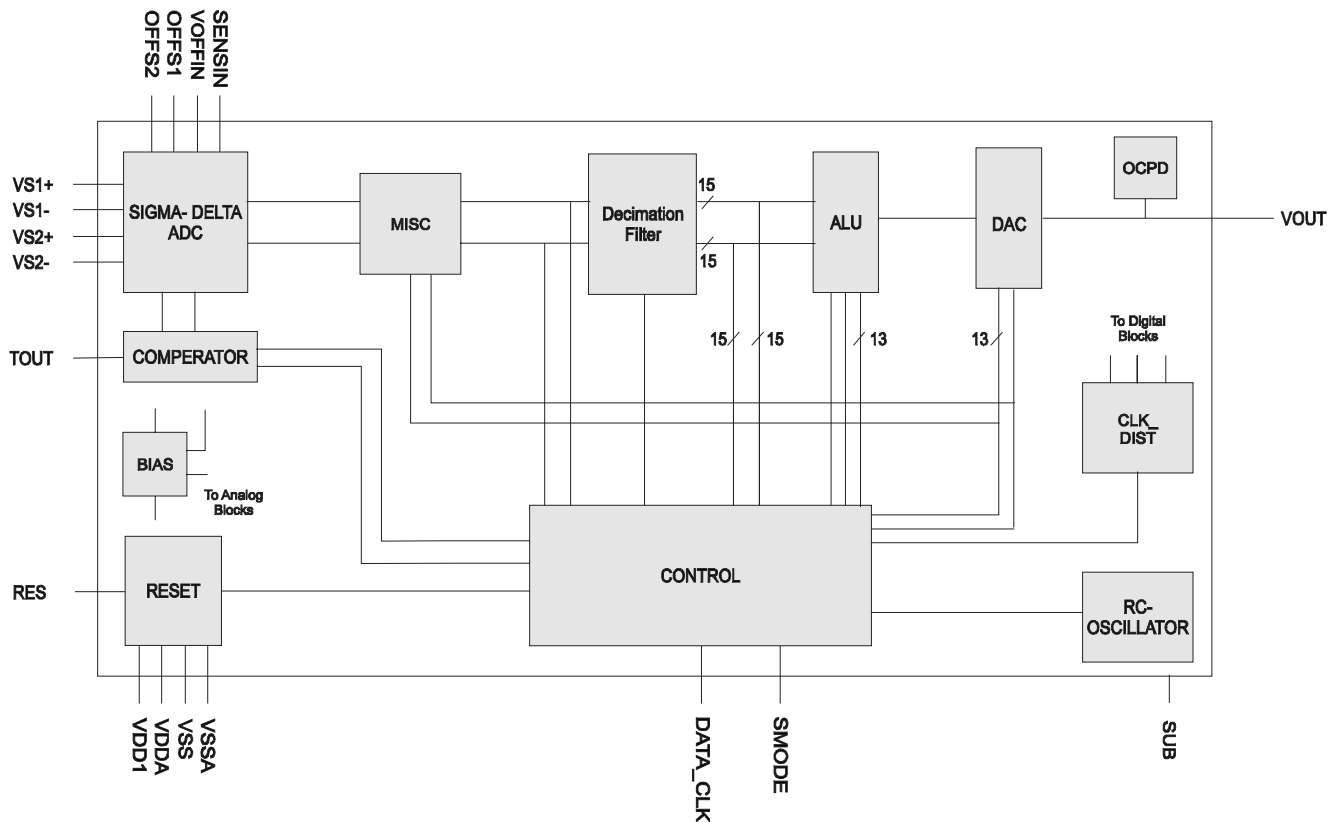

Figure 11: Detailed block diagram of the UZZ9000

The following list gives a short description of the relevant blocks.

1. The **ADC** block contains two Sigma Delta AD converters, a sensor offset correction circuitry and the circuitry required for the sensitivity adjustment and offset adjustment of the chip output voltage curve.

## Contactless Angle Measurement using KMZ41 and UZZ9000

## Application Note AN98097

2. **DF** stands for the two digital low pass decimation filter which convert the low resolution high speed bit stream coming from the Sigma Delta converters into a low speed digital word.
3. The **ALU** block derives an angle value from the two digital inputs using the CORDIC algorithm
4. The **DAC** converts the digital output of the ALU block to an analog output voltage.
5. The block **CNTRL** provides the clock and the control signals for the chip
6. The **COMP** block generates binary output signals used for sensor trimming.
7. The **RESET** block supplies a reset signal during power-up and power-down when the power supply is below a certain value
8. The **OSC** unit generates the master clock

On entering the IC, the analog measurement signals are converted to digital data by an ADC. The ADC is a Sigma-Delta modulator, employing a 4th order continuous time architecture, with an over-sampling ratio of 128 to achieve high resolution. The output of the converter is a digital bit-stream at the over-sampling frequency of typically 500 kHz. The bit stream is fed into a decimation filter which performs both low pass filtering and down-sampling. There are two input channels of the IC, each of which has its own ADC and decimation filter. The two decimation filter outputs are digital words of 15-bit at a lower frequency of typically 3.9 kHz. This is the typical sampling frequency of the sensor system. The digital representations of the two signals are then used to calculate the current angle. This calculation is done using the so-called CORDIC algorithm. The angle is represented with a 13-bit resolution. A resistive-string DAC converts this digital data into an analog voltage output.

The UZZ9000 has an overall accuracy better than 0.45°. This limit holds at all angular ranges up to 180° and over the specified ambient temperature range of -40°C to +150°C. Details of timing, input and output characteristic and the trimming process are discussed in the following sections. The following TABLE 13 gives the pinning of the UZZ9000 that comes in a standard SO24 package.

**TABLE 2: Pinning of the UZZ9000**

Pin	Symbol	I/O*	Type*	Description
1	+Vo2	I	A	positive output voltage of sensor 2 (Wheatstone bridge 2)
2	+Vo1	I	A	positive output voltage of sensor 1 (Wheatstone bridge 1)
3	VDD	S	A	digital supply
4	VSS	S	A	digital ground
5	VSSA	S	A	analog ground
6	RES	I	D	resets the digital part of the UZZ9000, pin is active high. If not used, pin can be left unconnected (internal pull-down resistor) or connect it to ground.
7	TEST1	I	D	used for production tests, can be left unconnected (internal

## Contactless Angle Measurement using KMZ41 and UZZ9000

## Application Note AN98097

Pin	Symbol	I/O*	Type*	Description
				pull-down resistor) or connect it to ground
8	TEST2	O	D	used for production tests, must be left unconnected
9	DATA_CLK	I	D	data clock, used when setting the UZZ9000 into trim mode, can be left unconnected (internal pull-down resistor) or connect it to ground
10	SMODE	I	D	serial mode programmer, used when setting UZZ9000 into trim mode, can be left unconnected (internal pull-down resistor) or connect it to ground
11	TEST3	O	D	used for production tests, must be left unconnected
12	VOUT	O	A	Voltage output connected to the DAC that converts the digital representation of the angle into the analog domain (normal operation mode), or to diagnostic voltages (in the case of an error).
13	SENSIN	I	A	Trimming input for sensitivity (different angular ranges) of the output curve.
14	VOFFIN	I	A	Trimming input for zero point adjustment of the output curve.
15	OFF2	I	A	offset trimming input for sensor 2 (Wheatstone bridge 2)
16	OFF1	I	A	offset trimming input for sensor 1 (Wheatstone bridge 1)
17	VDDA	S	A	analog supply
18	VSSA	S	A	analog ground
19	TEST4	I	D	used for production tests, can be left unconnected (internal pull-down resistor) or connect it to ground
20	TEST5	I	D	used for production tests, can be left unconnected because of an internal pull-down resistor or connect it to ground
21	VDD	S	A	digital supply
22	TOUT	O	D	used in trim mode, gives the offset corrected signal of sensor 1 or sensor 2, must be left unconnected in application
23	-Vo2	I	A	negative output voltage of sensor 2 (Wheatstone bridge 2)
24	-Vo1	I	A	negative output voltage of sensor 1 (Wheatstone bridge 1)

\* A = analog pin, D = digital pin, S = supply, I = input, O = output

## 5.2 Characteristics of Input and Output Signals

The input stage of the UZZ9000 expects sinusoidal signals. The electrical characteristics of these signals are defined in TABLE 3. These values correspond to the KMZ41 sensor specification.

**TABLE 3: Limits of the UZZ9000 input signals**

Parameter	Min	Max	Units
Analog supply voltage	4.5	5.5	V
Differential input voltage range (peak voltage) referred to analog supply voltage (including any offset)	+/- 6.6*	+/- 28	mV / V
Differential input voltage offset referred to analog supply voltage	-2	+2	mV / V
Common mode range referred to the analog supply voltage	490	510	mV / V

\* If signals of both channels are below this limit at the same time, the magnet lost error condition becomes active (see section 5.6).

The output stage of the UZZ9000 is able to drive any external output load as defined in TABLE 4. Please note that an external pull-up or pull-down resistor is not required for applications as those resistors are already provided on-chip.

**TABLE 4: Limits for the output load of the UZZ9000**

Parameter	Symbol	Min	Nom	Max	Units
Output load pull down	$R_{Lpd}$	2.5			k $\Omega$
Output load pull up (+6V to +14V)	$R_{Lpu}$	5			k $\Omega$
Output capacitance *	$C_L$		0.05	200	nF

\* If the output capacitance is greater than 50 pF (nominal value), a resistor of  $R \geq 300 \Omega$  has to be connected in series with the output to ensure stability of the output stage. As this affects the accuracy, the capacitive load should be limited to the nominal value.

The valid output voltage range for a valid angle is nominally 5.5% to 95% VDDA. Above and below this range is the diagnostic region. This region is discussed further in section 5.5. TABLE 5 and Figure 12 describe the details of the output curve characteristic.

**TABLE 5: Partitions of the UZZ9000 output curve**

Parameter	Symbol	Min	Nom	Max	Units
<b>Normal operating range:</b>					
Min Value	$V_{Out\_N\_Min}$	5.0	5.5	6.0	% VDDA
Max Value	$V_{Out\_N\_Max}$	94.0	94.5	95.0	% VDDA
<b>Lower diagnostic range:</b>	$V_{Out\_DL}$	0		4	% VDDA
<b>Upper diagnostic range:</b>	$V_{Out\_DU}$	96		100	% VDDA

As can be seen from Figure 12, the mechanical input angular range between  $\alpha_1$  and  $\alpha_2$  is linearly converted to output voltages between 5.5% VDDA and 94.5% VDDA. The best straight line is the ideal output characteristic of the UZZ9000. The tolerance band in Figure 12 indicates the limits in which the actual output curve may be found.

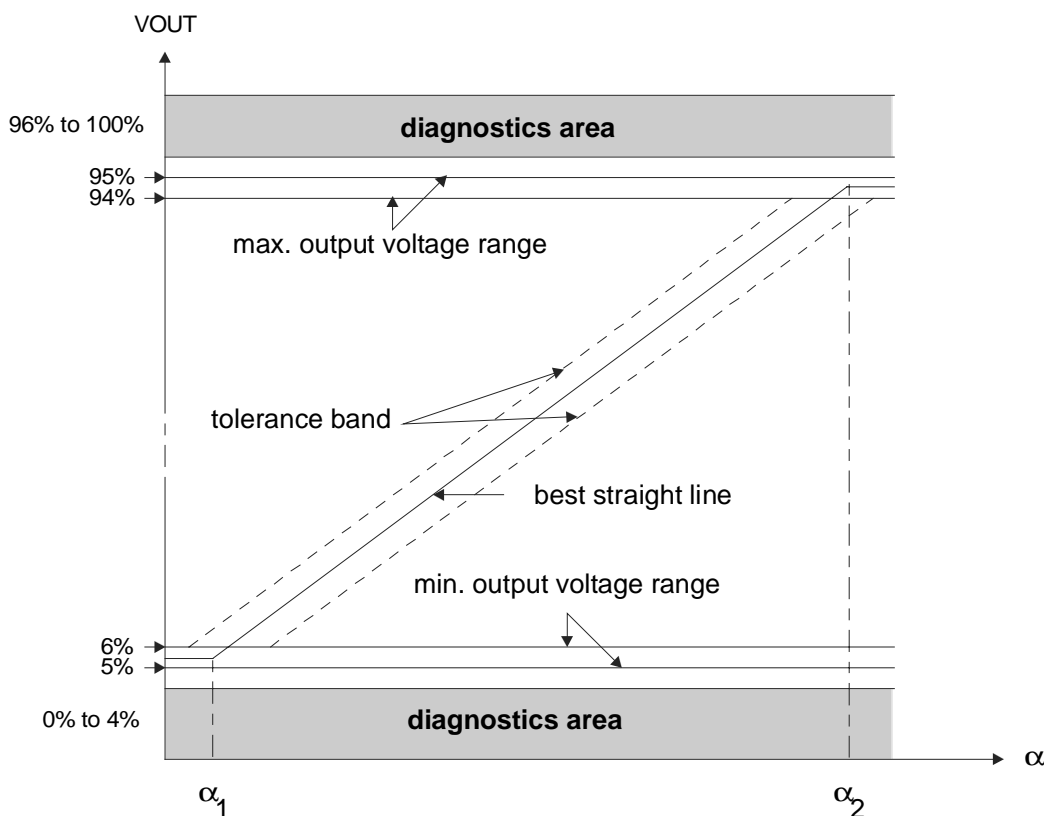

Figure 12: Detailed output curve characteristic of the UZZ9000

The maximum overall angular error under any specified conditions is guaranteed to be less than  $0.45^\circ$ . Assuming an angular range of  $180^\circ$ , the output voltage error is calculated as follows:

$$E_{180^\circ} < \frac{0.45^\circ}{180^\circ} (94.5 - 5.5) \% VDDA = 0.22 \% VDDA \quad (7)$$

It becomes clear that this output voltage error directly depends on the chosen angular range. The absolute angular error, however, is approximately the same in every angular range.

### 5.3 Adjusting the Angular Range and the Zero Point Offset

In order to fit to different applications, the mechanical input angular range of the UZZ9000 and the zero point of the output curve are user programmable. This section describes how to select a certain mode.

#### 5.3.1 Changes of the Output Curve Characteristic

By changing the angular range, the output curve is manipulated as shown in Figure 13. Without any zero point offset, the sensitive part starts at mechanically  $0^\circ$  ( $\alpha_1 = 0^\circ$ ). When using a KMZ41 sensor, the maximum angular range  $\Delta\alpha$  is  $0^\circ$  to  $180^\circ$ . For the UZZ9000, smaller angular ranges can be set. In this case,  $\alpha_2$  becomes smaller than  $180^\circ$  and the output curve is clipped at this position. The location of discontinuity  $X_D$  (change from lower to upper clipping area) depends on the adjusted range and can be calculated as follows:

$$X_D = \Delta\alpha + \frac{180^\circ - \Delta\alpha}{2} \quad (8)$$

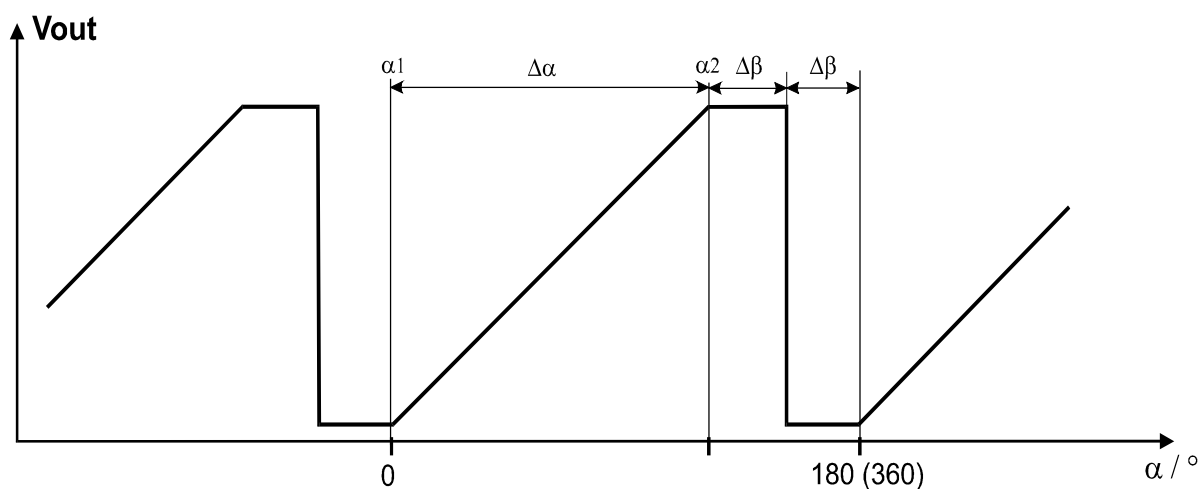

Figure 13: Output curve for different angular ranges. Note that when using MR-sensors (KMZ41), the signal period is  $0^\circ$  to  $180^\circ$  as the signals are proportional to  $\sin 2\alpha$  and  $\cos 2\alpha$ .



In order to compensate tolerances, the zero point of the output curve can be shifted by  $\pm 5^\circ$  in steps of  $0.5^\circ$ . The effect of this measure is shown in Figure 14. Now  $\alpha_1$  is no longer identical with mechanically  $0^\circ$ , but with the zero point shift  $X_{off}$ . Consequently, the location of discontinuity  $X_D$  calculates according to Equation (9):

$$X_D = x_{off} + \Delta\alpha + \frac{180^\circ - \Delta\alpha}{2} \quad (9)$$

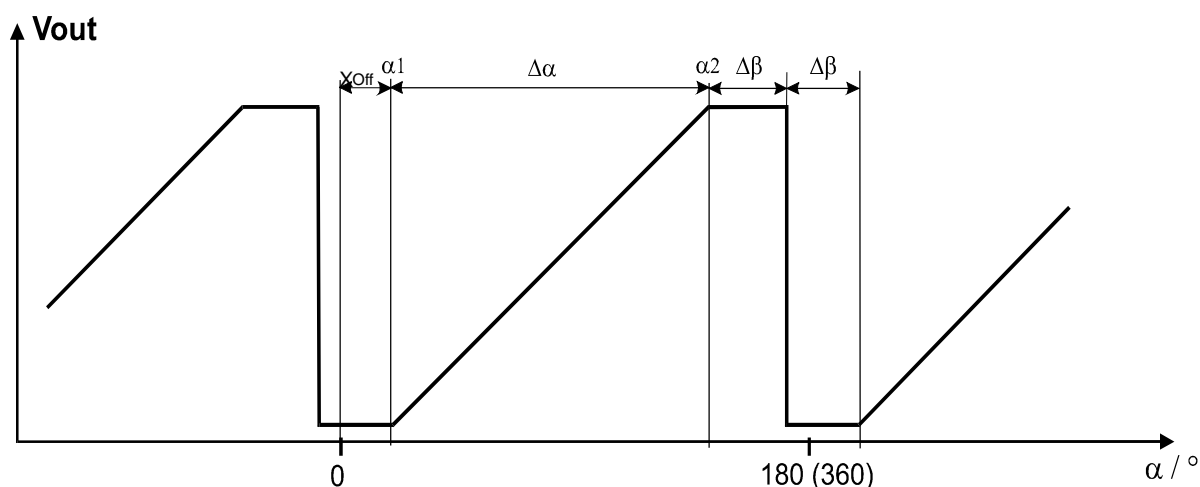

Figure 14: Output curve for different angular ranges including a zero point offset. Note that when using MR-sensors (KMZ41), the signal period is  $0^\circ$  to  $180^\circ$  as the signals are proportional to  $\sin 2\alpha$  and  $\cos 2\alpha$ .

### 5.3.2 How to Set a Certain Angular Range

To select one of 16 different angular ranges, an external voltage (see TABLE 6) has to be applied to pin 13 of the UZZ9000 (SENSIN). During the IC's initialization phase, which directly follows power-on reset or an external reset, this voltage is read and then converted into the digital domain. The digital value is stored until the next reset state occurs. Consequently, the angular range cannot be changed during normal operation but is still fixed after initialization phase.

Please note that the voltage at pin 13 must be ratiometric to  $V_{DDA}$  and also stable over temperature and lifetime. This is ensured, for instance, when providing this voltage via a (trimmable) resistor divider connected to  $V_{DDA}$ , which is the analog supply of the UZZ9000. The following TABLE 6 defines the fractions of the supply voltage  $V_{DDA}$  that must be fed to pin 13 to select a certain range. Please note that when using the  $30^\circ$  angular range, a constant zero point offset of  $15^\circ$  is added. Consequently, when using the  $30^\circ$  range, the zero point offset can be programmed between  $10^\circ$  and  $20^\circ$  only (see next section).

**TABLE 6: Definition of voltages to set one of the UZZ9000 angular ranges**

Angular Range	Min	Nom	Max	Units
0° to 30° (*)	33.07	33.33	33.59	% VDDA
0° to 40°	35.30	35.56	35.82	% VDDA
0° to 50°	37.52	37.78	38.04	% VDDA
0° to 60°	39.74	40.00	40.26	% VDDA
0° to 70°	41.96	42.22	42.48	% VDDA
0° to 80°	44.18	44.44	44.70	% VDDA
0° to 90°	46.41	46.67	46.93	% VDDA
0° to 100°	48.63	48.89	49.15	% VDDA
0° to 110°	50.85	51.11	51.37	% VDDA
0° to 120°	53.07	53.33	53.59	% VDDA
0° to 130°	55.30	55.56	55.82	% VDDA
0° to 140°	57.52	57.78	58.04	% VDDA
0° to 150°	59.74	60.00	60.26	% VDDA
0° to 160°	61.96	62.22	62.48	% VDDA
0° to 170°	64.18	64.44	64.70	% VDDA
0° to 180°	66.14	66.67	66.93	% VDDA

(\*) When choosing the angular range from 0° to 30°, a constant zero point offset of 15° is added.

### 5.3.3 How to Set a Zero Point Offset

To adjust the zero point offset or to set it to 0°, an external voltage has to be applied to the UZZ9000 at pin 14 (VOFFIN). The function is similar to the one described in the previous section: After reset the voltage is read, converted into the digital domain and then stored until another reset state occurs. Consequently, the zero point offset cannot be adjusted without a reset.

As said before, it is recommended to use a resistor divider connected to VDDA to generate this voltage. TABLE 7 defines the allowed voltage ranges as a percentage of the supply VDDA.

**TABLE 7: Definition of the voltages to select a certain zero point offset**

Zero Point Offset	Min	Nom	Max	Units
-5°	33.07	33.33	33.59	% VDDA
-4.5°	34.74	35.00	35.26	% VDDA
-4°	36.40	36.66	36.92	% VDDA
-3.5°	38.07	38.33	38.59	% VDDA
-3°	39.74	40.00	40.26	% VDDA
-2.5°	41.40	41.66	41.92	% VDDA
-2°	43.07	43.33	43.59	% VDDA
-1.5°	44.74	45.00	45.26	% VDDA
-1°	46.40	46.66	46.92	% VDDA
-0.5°	48.07	48.33	48.59	% VDDA
0.0°	49.74	50.00	50.26	% VDDA
0.5°	51.40	51.66	51.92	% VDDA
1.0°	53.07	53.33	53.59	% VDDA
1.5°	54.74	55.00	55.26	% VDDA
2.0°	56.40	56.66	56.92	% VDDA
2.5°	58.07	58.33	58.59	% VDDA
3.0°	59.74	60.00	60.26	% VDDA
3.5°	61.40	61.66	61.92	% VDDA
4.0°	63.07	63.33	63.59	% VDDA
4.5°	64.74	65.00	65.26	% VDDA
5.0°	66.40	66.66	66.92	% VDDA

#### 5.4 Offset Trimming

To achieve a linear output characteristic, it is necessary to adapt the offsets of the two input signals to the input stage of the UZZ9000. For this reason a sensor offset cancellation procedure was implemented in the UZZ9000 which is started by sending a special serial data protocol to the UZZ9000. This trimming procedure is required for both input signals.

## 5.4.1 Trim Interface

The serial interface used to switch the UZZ9000 into trim mode consists of the two terminals SMODE (pin 10) and DATA\_CLK (pin 9). The structure of this protocol is shown in Figure 15.

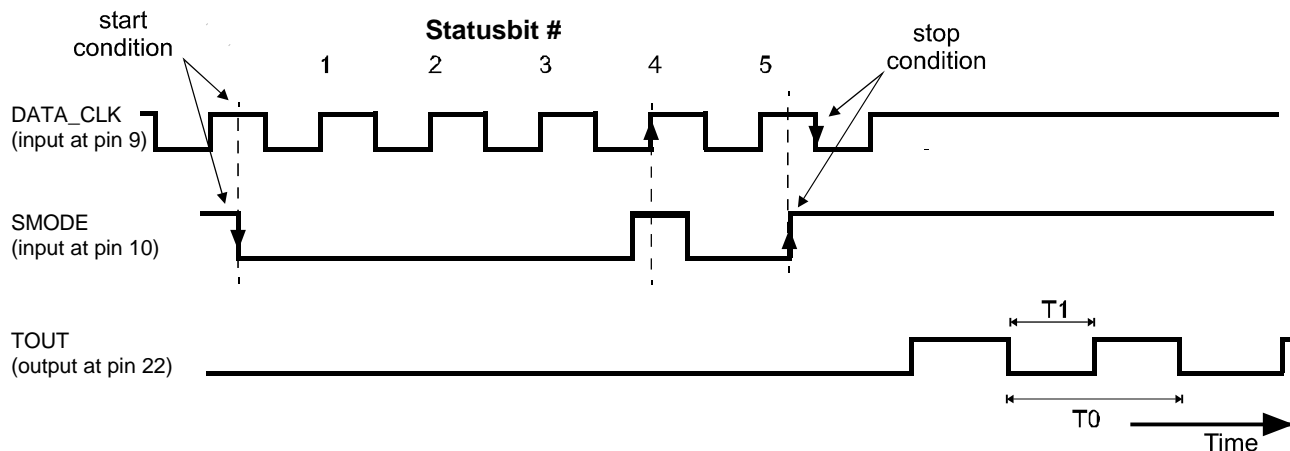

Figure 15: Protocol used to set the UZZ9000 into trim mode.

All signal levels at DATA\_CLK and SMODE must be chosen according to the requirements listed in TABLE 8. Because of the asynchronous protocol, the following points have to be taken into account:

The protocol starts with a falling edge at SMODE, which must occur at a high level of the DATA\_CLK. The next five bits are used for coding of the message send to the UZZ9000. They are transferred via SMODE and are sampled with the rising edge of DATA\_CLK. During the fifth high level output of DATA\_CLK (counted from the start condition onwards), a rising edge must appear at SMODE and afterwards DATA\_CLK has to change one more time to low level in order to successfully complete the protocol.

**TABLE 8: Definition of the trim interface signals**

Parameter	Min	Nom	Max	Unit
supply voltage VDD of UZZ9000	4.5	5.0	5.5	V
low level of DATA_CLK, SMODE	0		5	%VDD
high level of DATA_CLK, SMODE	95		100	%VDD
rise and fall time of signal edges of DATA_CLK and SMODE (from 10% VDD to 90% VDD and vice versa)	8			ns
Frequency of DATA_CLK	0.1		1	MHz

#### 5.4.2 How to Enter the Trim Mode

The status bits to be transmitted to the UZZ9000 are shown in TABLE 9. Also please note that a complete protocol has to be sent to return to normal operation. Another possibility to leave the trim mode is to reset the device.

**TABLE 9: Programming of trim modes**

Mode	Status Bits				
	1	2	3	4	5
enter trim mode for sensor input channel 1	0	0	0	1	0
enter trim mode for sensor input channel 2	0	0	1	0	0
leave trim mode for either input channels	0	0	0	0	0

After entering one of the trim modes, a square wave output is visible at the terminal TOUT (pin 22) provided there is a dynamic input signal.

#### 5.4.3 Offset Calibration

To make use of the build-in trimming procedure of the UZZ9000, it is necessary to generate dynamic sensor signals at its inputs. When the KMZ41 is used, a rotating permanent magnet in front of the sensor can easily generate these input signals. The principle of this set-up is shown in Figure 16.

Please note that the absolute rotational speed of the permanent magnet is not that important but it must be constant over time. Please further note that the rotational axis of the motor and magnet must be aligned exactly with the center of the KMZ41 package as shown in Figure 16. It is not necessary to use the same magnet for both trimming and application, but after trimming, the KMZ41 and UZZ9000 must be treated as one unit. The trimming procedure is as follows.

When the UZZ9000 has been switched to trim mode and sinusoidal sensor voltages are applied to its inputs, then the terminal TOUT (pin 22) immediately shows a square wave signal. This square wave signal has the same frequency as the sensor signal and a duty cycle T1/T0 as shown in Figure 15 previously.

# Contactless Angle Measurement using KMZ41 and UZZ9000

# Application Note AN98097

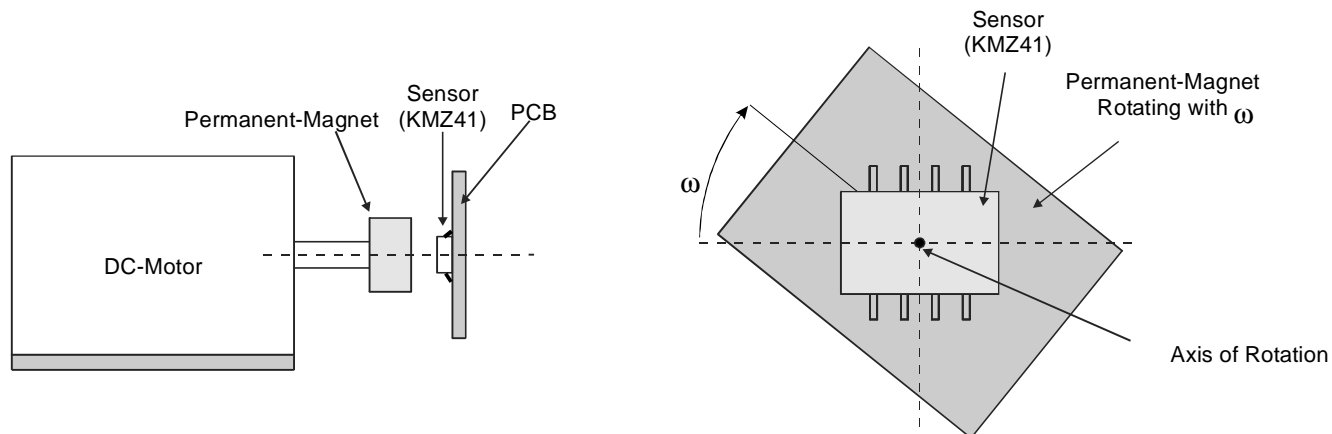

Figure 16: Proposal for a mechanical set-up to trim the UZZ9000

At a duty cycle of 50%, the offset for the selected channel is virtually eliminated. Therefore, the voltage at OFF1 (PIN16, channel 1) or OFF2 (PIN15, channel 2), respectively, has to be adjusted until this target is achieved. The trimming voltages OFF1 and OFF2 must be ratiometric to the UZZ9000 VDDA supply and must not vary more than 0.1 % VDDA with temperature and over lifetime. As already proposed for adjusting the angular ranges and zero point offset, these properties can be ensured, for example, when using a trimmable resistor divider connected to VDDA.

When building up an automatic trimming station for mass production, it is recommended to firstly determine the actual trim voltage to be fed to OFF1 and OFF2 as a fraction of VDDA. Afterwards, the resistor dividers are trimmed according to the requirements found. This procedure will be much faster compared with trying to trim the resistors step by step to get 50% duty cycle. In practice, laser trimmable resistors used for both divider elements have shown good results. Using resistors of the same material is important to get a similar temperature coefficient. Please note that for duty cycle measurements, the measuring device should be set into averaging mode in order to eliminate the influence of short spikes or noise. TABLE 10 summarises the recommended trim parameters:

**TABLE 10: Definitions and recommendations of trim parameters**

Parameter	Symbol	Min	Nom	Max	Unit
Frequency of the motor	$f_0$	20		30	$s^{-1}$
Frequency of the sensor input signals (KMZ41)	$2 f_0$	40		60	Hz
Stability of the rotational speed over one signal period	$\Delta f$			0.05	% $f_0$
Limits for the duty cycle of nominal 50% during trimming		49.96		50.04	%

## Contactless Angle Measurement using KMZ41 and UZZ9000

## Application Note AN98097

Parameter	Symbol	Min	Nom	Max	Unit
Variation of the voltages provided at OFF1 and OFF2 with temperature and during lifetime				0.1	%VDDA
Voltage range for OFF1 and OFF2		33.3		66.7	%VDDA
Input signal offset range to be aligned by OFF1 and OFF2. Values are referred to VDDA. The min value corresponds to the min value for OFF1 and OFF2 (33.3% VDDA), and vice versa.		-2		2	mV / V

### Example:

The following example serves to demonstrate the meaning of these limits and allows the calculation of the system accuracy if other values are applied.

Assuming sinusoidal sensor signals with the amplitude  $A$ , then the relation between an DC offset  $\Delta x$  and the measured duty cycle  $T1/T0$  is as follows:

$$\Delta x = A \sin(\pi \cdot (0.5 + T1/T0)) \quad (10)$$

At room temperature and 5V supply voltage, the typical signal amplitude  $A$  of the KMZ41 is 78 mV. Consequently, at a duty cycle of 50.04% (or 49.96%) the remaining offset voltage is:

$$\Delta x = 78 \text{ mV} \sin(\pi \cdot (0.5 + 0.5004)) = -0.098 \text{ mV} \quad (11)$$

As a result, the remaining offset is 0.13% referred to the signal amplitude of 78 mV. The angular error caused by this offset is discussed in section 7.

The other parameter specified is the drift of the voltages applied to OFF1 and OFF2 with temperature and over lifetime. It is specified to be less than 0.1% VDDA. The maximum voltage range for OFF1 and OFF2 is 33.3 % VDDA which is used to align the input signal offset range of +/- 2 mV / V. Consequently, changes of OFF1 or OFF2 by 0.1% VDDA will cause offset voltages  $\Delta x$  of:

$$\Delta x = \frac{0.1\% \text{ VDDA}}{33.3\% \text{ VDDA}} \cdot 2 \cdot 2 \text{ mV / V} = 0.012 \text{ mV / V} \quad (12)$$

## Contactless Angle Measurement using KMZ41 and UZZ9000

## Application Note AN98097

At a supply voltage of 5V, the offset voltage caused by the drift of OFF1 and OFF2 is 0.06 mV for each channel. The resulting angular error due to this offset is discussed in section 7.

### 5.5 Reset

During reset, the output of the UZZ9000 VOUT is forced to nominal 5.5 % VDDA. This is the minimum value of normal operation.

In addition to the external reset pin (pin 6), the UZZ9000 provides an internal power-up / power-down reset logic which supervises the supply voltage continuously. When the supply voltage increases and reaches a safe level, reset becomes inactive and the device starts initialization after a nominal delay of 100 us. This is to ensure settling of all analog and digital sections. When the supply voltage leaves the safe voltage level, the device is reset immediately. This internal reset logic can be over-ridden by the external pin RES (pin 6) in all modes and at any time. The reset pin RES (pin 6) is active high. It is internally pulled down to VSS and therefore does not have to be connected if the function is not required.

As the UZZ9000 has two different voltage supplies, the power-up and power-down reset operates as follows:

#### 1. Power-Up

VDD or VDDA	$\leq 3.3$ V	reset active
VDD and VDDA	$\geq 4.3$ V	reset not active, reset will switch from high to low after a delay of 100 us.

#### 2. Power-Down

VDD or VDDA	$\leq 3.3$ V	reset active
VDD and VDDA	$\geq 4.2$ V	reset not active, device active

If the supply voltage rises, the device is switched into active mode as soon as VDD AND VDDA reach the power-up switching level, which lies between 3.3 V and 4.3 V, and the delay of about 100 us has elapsed. In contrast, if the supply voltage at VDD OR VDDA goes below the power-down limit, which lies between 3.3 V and 4.2 V, reset becomes active immediately. Due to possible ripples on the supply voltage, a hysteresis of 100 mV is implemented between the power-up and power-down switching voltage levels. The following TABLE 11 summarises the specified limits.

**TABLE 11: Definitions of switching levels of the build-in reset logic**

Parameter	Min	Nom	Max	Unit
Switching voltage for falling VDDA OR VDD	3.3		4.2	V
Switching Hysteresis		0.1		V



## Contactless Angle Measurement using KMZ41 and UZZ9000

## Application Note AN98097

Parameter	Min	Nom	Max	Unit
Switching voltage for rising VDDA AND VDD	3.3		4.3	V
Delay for starting the initialization of the UZZ9000 when VDD AND VDDA have risen above the power-up switching level		100		us

### 5.6 Diagnostic

The UZZ9000 provides some powerful diagnostics features that allow the user to recognize certain failures of the device or system. A failure has occurred when the output voltage VOUT lies above or below the normal operation range (see Figure 12). Either one of the diagnostic areas is reached during any of the following conditions:

1. Short circuit between VOUT and VSS ( $R < 1 \Omega$ )
2. Short circuit between VOUT and VDD ( $R < 1 \Omega$ )
3. Disconnection of VDD when the load is pulled down
4. Disconnection of VSS when the load is pulled up
5. Invalid input signal from the sensor, e.g. Magnet Lost. This failure is assumed when the offset corrected input signal of sensor 1 AND sensor 2 is below +/- 15 mV (tolerance +/- 5%).

In the output buffer block, the internal pull-up and pull-down resistors guarantee that VOUT will be pulled to one of the power supplies when the other supply is disconnected and so VOUT reaches the diagnostic region even in the case when there is no output load.

If the external load is a pull-down resistor, then the device will go into the diagnostic area if VDD is disconnected, but not if VSS is disconnected. Similarly, if the load is a pull-up resistor, then the device will go into the diagnostic area if VSS is disconnected, but not if VDD is disconnected. **Note that there is no need to connect an output load to the UZZ9000.**

After recovering from short circuit to ground or supply voltage, the chip returns to the normal operation mode without any damage. There is no time limitation regarding short circuit of VOUT.

### 5.7 Measurements Dynamics

The UZZ9000 provides an on-chip RC Oscillator that generates the clock for the whole device. Consequently, no external clock supply is required for the measurement system.

The nominal clock frequency of the on-chip oscillator is 4 MHz at room temperature. It varies over temperature. At -40°C, the clock frequency may reduce down to 2.8 MHz. At higher temperatures, however, a frequency up to 5.2 MHz may occur. Consequently, this influences the dynamics of measurements. From the application point of view, two different effects have to be distinguished: The system delay, which means how long it takes until a changed input signal is recognized at the output, and the measurement update rate.

## Contactless Angle Measurement using KMZ41 and UZZ9000

## Application Note AN98097

The system delay is mainly caused by the settling time of the low pass decimation filter, which depends on the maximum frequency content (shape) of the input signals and the clock frequency. The following maximum values can be expected for the entire system delay (see TABLE 12):

**TABLE 12: System delay and update rates of the UZZ9000**

Parameter / Conditions	Min	Typ	Max	Unit
System delay defined as the time passes by until 95% of the final value is reached:				
- Max. signal frequency < 200Hz			0.6	ms
- Transients (Step response)			1.2	ms
Measurement update rate:				
- -40°C	0.37			ms
- 25°C (room temperature)		0.26		ms
- 150°C			0.20	ms

The measurement update rate, however, is directly related to the oscillator frequency. At room temperature, a new value is available every 0.26 ms. When looking at the entire temperature range of the UZZ9000, update rates between 0.37 ms and 0.2 ms are possible (see TABLE 12).

## 6. SCHEMATICS FOR CONNECTING KMZ41 AND UZZ9000

### 6.1 Single Measurement System

As shown in Figure 5, four wires are required to connect KMZ41 and UZZ9000. For these connections, both chips provide terminals with identical names. The corresponding pin numbers are listed in TABLE 13.

TABLE 13: Pinning of the KMZ41 and UZZ9000 signal lines

	<b>-Vo1</b>	<b>+Vo1</b>	<b>-Vo2</b>	<b>+Vo2</b>
<b>KMZ41 (SO 8)</b>	Pin 1	Pin 5	Pin 2	Pin 6
<b>UZZ9000 (SO 24)</b>	Pin 24	Pin 2	Pin 23	Pin 1

Connecting these pins name by name, e.g. Pin 1 of the KMZ41 with Pin 24 of the UZZ9000 etc., results in the following output characteristic:

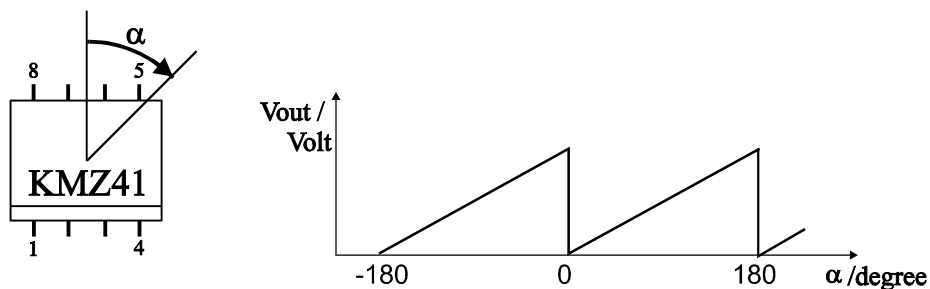

Figure 17: Definition of mechanical angle and the resulting output curve characteristic when using the standard connection between KMZ41 and UZZ9000

In some applications, however, it might be useful to shift the output curve. This can be easily achieved in steps of  $45^\circ$  by changing the pin connections between KMZ41 and UZZ9000. The different possibilities are listed in Figure 18.

# Contactless Angle Measurement using KMZ41 and UZZ9000

# Application Note AN98097

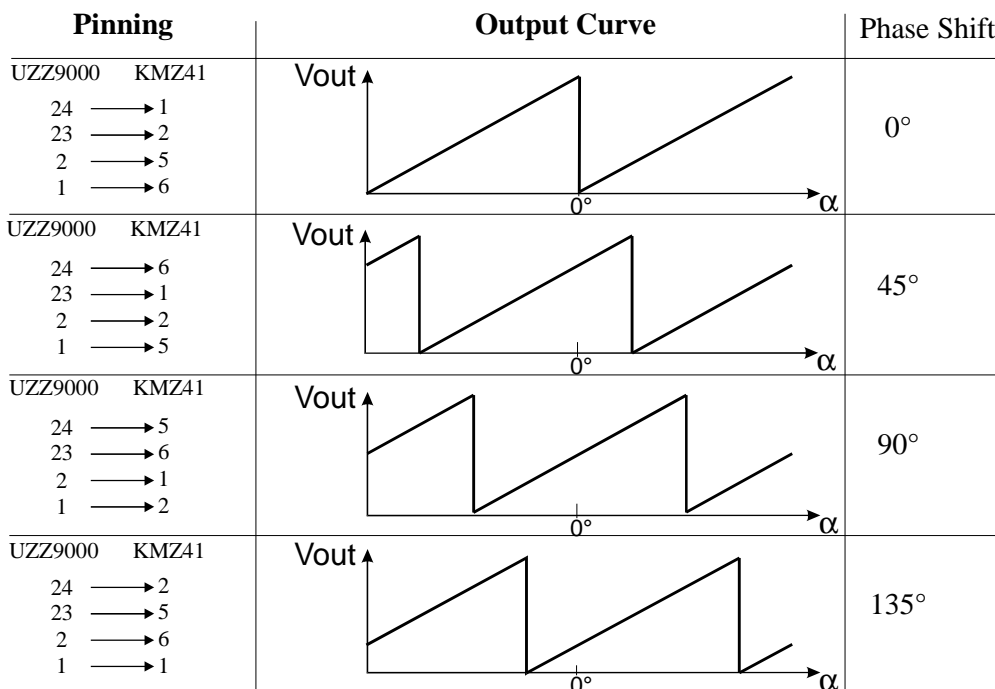

Figure 18: Possible connections between KMZ41 and UZZ9000 giving different zero point shifts of the output curve

## 6.2 Fault Tolerant Systems

In safety relevant applications it might become necessary to have two or more independent measurement systems for the same physical value. If using two independent KMZ41 sensors and two UZZ9000 in 180° angular range, a simple plausibility check can be made when having an anti-parallel output curve characteristic. This holds because then the sum of both output values is always 95% VDDA, independent of the actual angle. Please note that this easy control method is limited to the 180° angular range. If using other angular ranges, this check requires a more complex signal evaluation.

In general, there are two possibilities to achieve an anti-parallel output curve. These are explained in the following figures. In the first arrangement shown in Figure 19, the two sensors are mounted at the same position but opposite to each other (using the front and backside of one PCB or Flex Foil). Because of this mirror arrangement, the desired output characteristic is achieved by connecting both sensors in the standard way.

Conversely, when mounting the sensors on top of one another as shown in Figure 20, the connections have to be changed. In addition to these examples, many other output characteristics are achievable by applying the different configurations discussed in the previous section.

# Contactless Angle Measurement using KMZ41 and UZZ9000

# Application Note AN98097

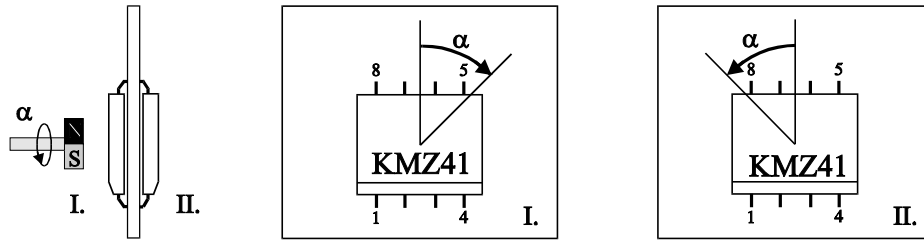

I. (standard)	UZZ9000    KMZ41 24 → 1 23 → 2 2 → 5 1 → 6	
II. (mirror)		
UZZ9000    KMZ41		I. Thick Line II. Thin Line
UZZ9000    KMZ41	24 → 1 23 → 2 2 → 5 1 → 6	

Figure 19: Two KMZ41 sensors mounted on opposite sides of one PCB (mirror arrangement).

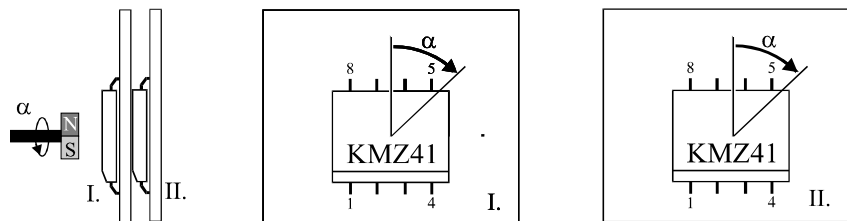

I. (standard)	UZZ9000    KMZ41 24 → 1 23 → 2 2 → 5 1 → 6	
II. (parallel)		
UZZ9000    KMZ41		I Thick Line II Thin Line
UZZ9000    KMZ41	24 → 1 23 → 6 2 → 5 1 → 2	

Figure 20: Two KMZ41 sensors mounted on top of one another (parallel arrangement)

## 6.3 Typical Application Circuit

Figure 21 shows a typical application circuit.

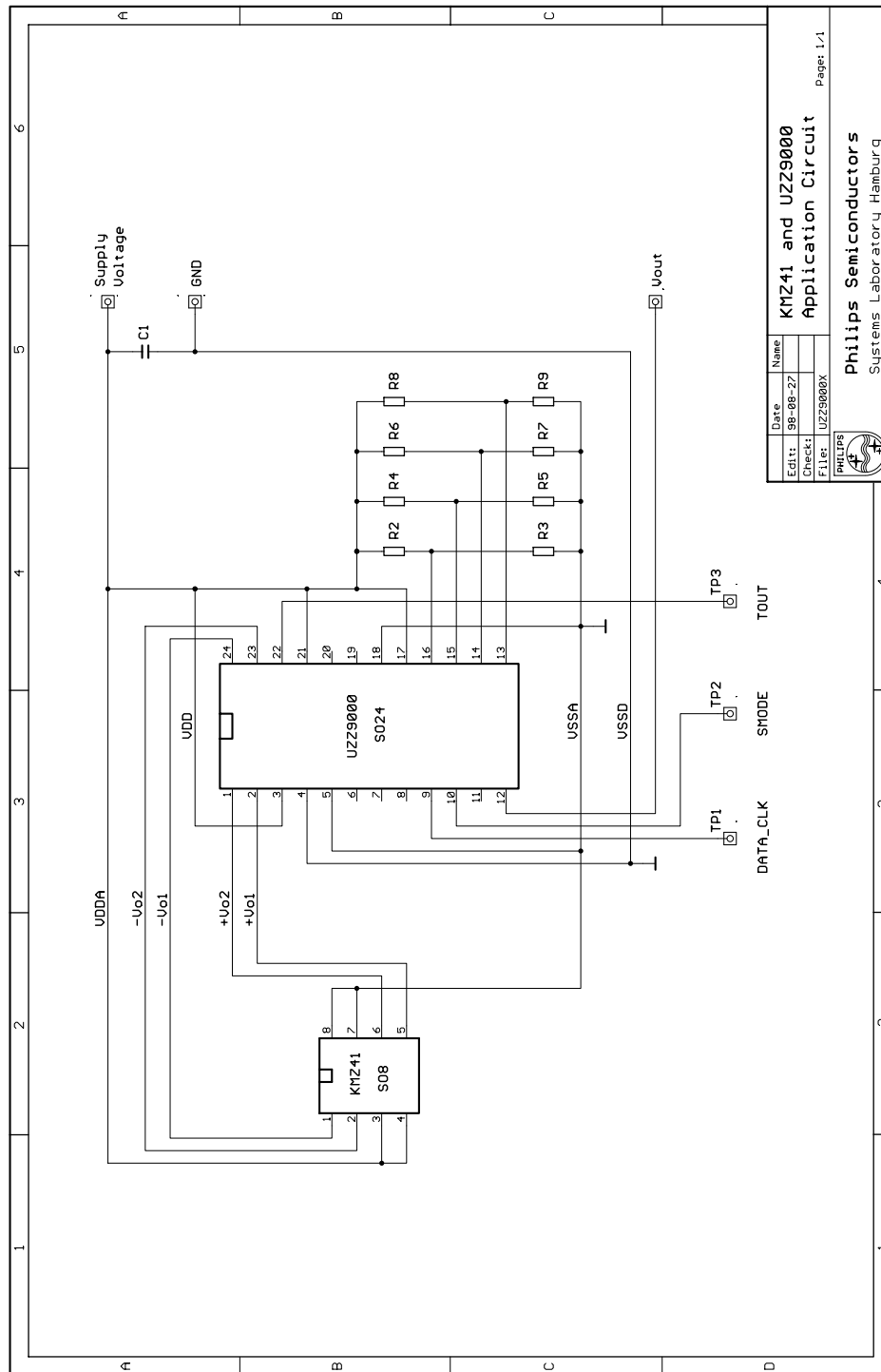

Date	Name
98-08-27	KMZ41 and UZZ9000
Edits:	Application Circuit
Check:	
File:	UZZ9000X
Philips Semiconductors Systems Laboratory, Hamburg	

Page: 1/1

Figure 21: Schematics of a typical application circuit

## 7 SYSTEM ACCURACY

### 7.1 Sensor KMZ41

There are three different errors that may be caused by non-adequate magnetic field arrangements. These are:

- Form deviations of the sensor signals (no sinusoidal shape) and hysteresis of the sensor response if the magnetic field  $H$  does not saturate the sensor.
- Form deviations of the sensor signals caused by a non-symmetrical sensor to magnet arrangement (inhomogeneous magnetic field).
- Influence of external magnetic fields influencing the primary field used for measurements.

The influence of external fields can not be described in general as these effects depend on the actual measurement set-up. Therefore this item is not discussed within this paper. The only possibility to get rid of external fields or to limit its impact is to use some kind of a magnetic shielding as discussed in section 4.

In addition to these magnetic effects, there are some non-ideal properties of the KMZ41 sensor affecting the system accuracy. These are discussed in section 7.1.3.

#### 7.1.1 Less Magnetic Field Strength

A complete saturation of the sensor would require the usage of an infinite magnetic field. Consequently, a complete saturation is impossible in practice and errors caused by fewer magnetic fields have to be taken into account. The magnetic field strength, which is proposed in this paper, is a compromise between the remaining error and magnet costs.

Insufficient magnetic field show two effects. The first one is the signal form error caused by a non-sinusoidal shape of the output signals (see Figure 22). Figure 23 shows the shape of the resulting measurement error. Due to its geometrical nature, the maximum and minimum values will always occur at the same locations for every sensor. Maximum values occur at the mechanical angles of  $11.25^\circ$ ,  $33.75^\circ$ ,  $56.25^\circ$ ,  $78.75^\circ$ ,  $101.25^\circ$ ,  $123.75^\circ$ ,  $146.25^\circ$  and  $168.25^\circ$ . No measurement errors occur at  $22.5^\circ$ ,  $45^\circ$ ,  $67.5^\circ$ ,  $90^\circ$ ,  $112.5^\circ$ ,  $135^\circ$ ,  $157.5^\circ$  and  $180^\circ$ .

Figure 24 shows the relation between the magnetic field strength  $H$  and the maximum peak error  $E_{\text{Form}}$  that may occur. At the recommended magnetic field strength of 100 kA/m, the measurement error is less than  $0.04^\circ$  and therefore negligible. The signal form error is reversible and does not depend on the history, as it is the case for hysteresis effects.

Hysteresis effects become visible if the angle turns back and forth over larger angular ranges as shown in Figure 25. The positions where these errors occur depend on the direction of movement. If fields become stronger, the hysteresis zones shrink to smaller areas around the positions  $0^\circ$ ,  $45^\circ$ ,  $90^\circ$  and  $135^\circ$ . Figure 24 also gives the maximum error caused by hysteresis effects. These are less than the errors caused by the signal form error.

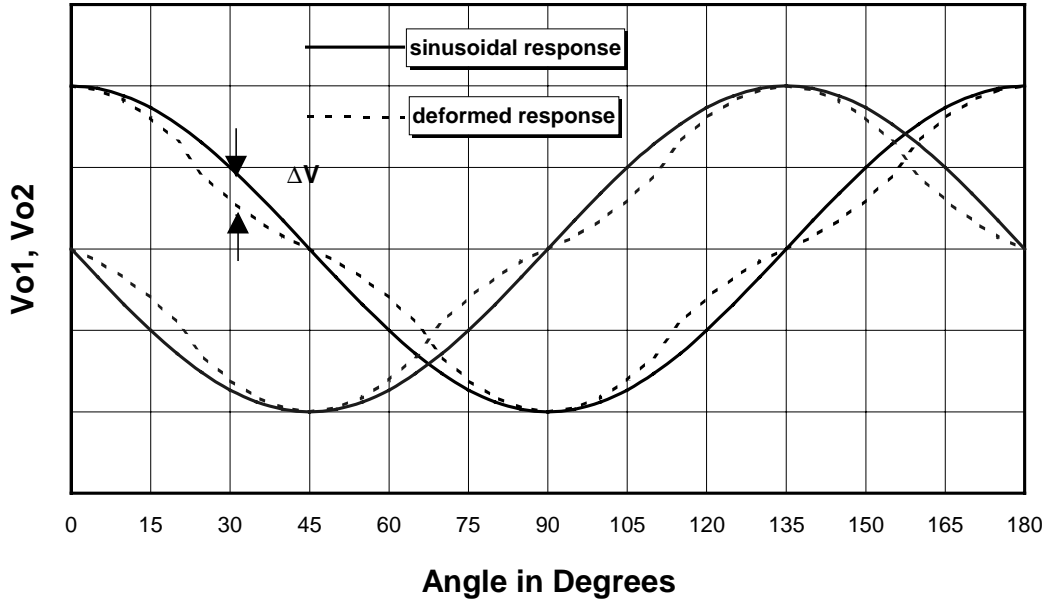

Figure 22: Signal form error of KMZ41 output signals caused by too low magnetic field not saturating the sensor

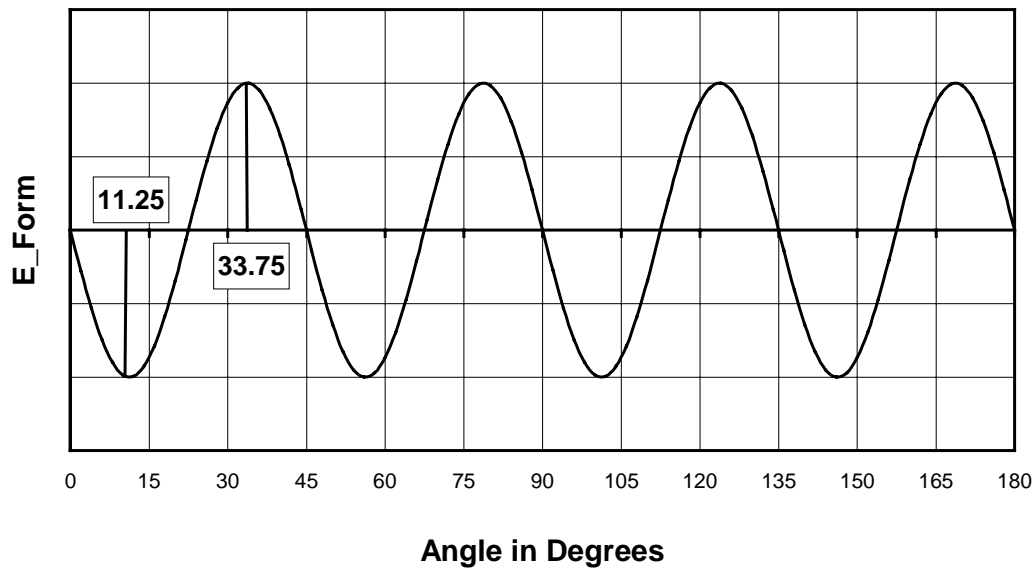

Figure 23: Shape of the measurement errors caused by the non-ideal sensor signals given in Figure 22.



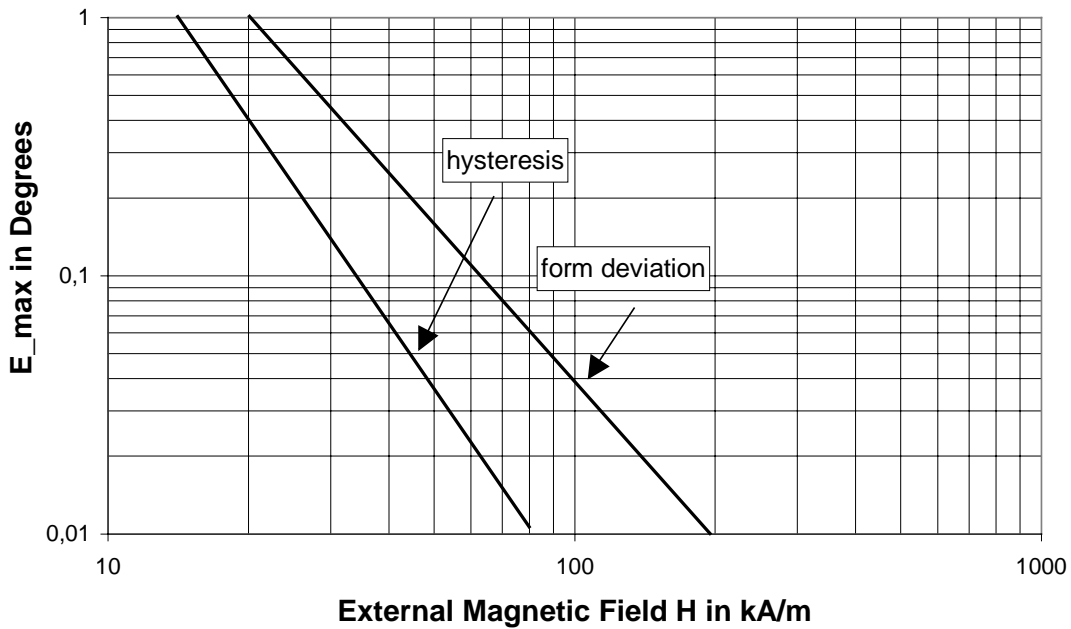

Figure 24: Maximum measurement error caused by signal form error and hysteresis

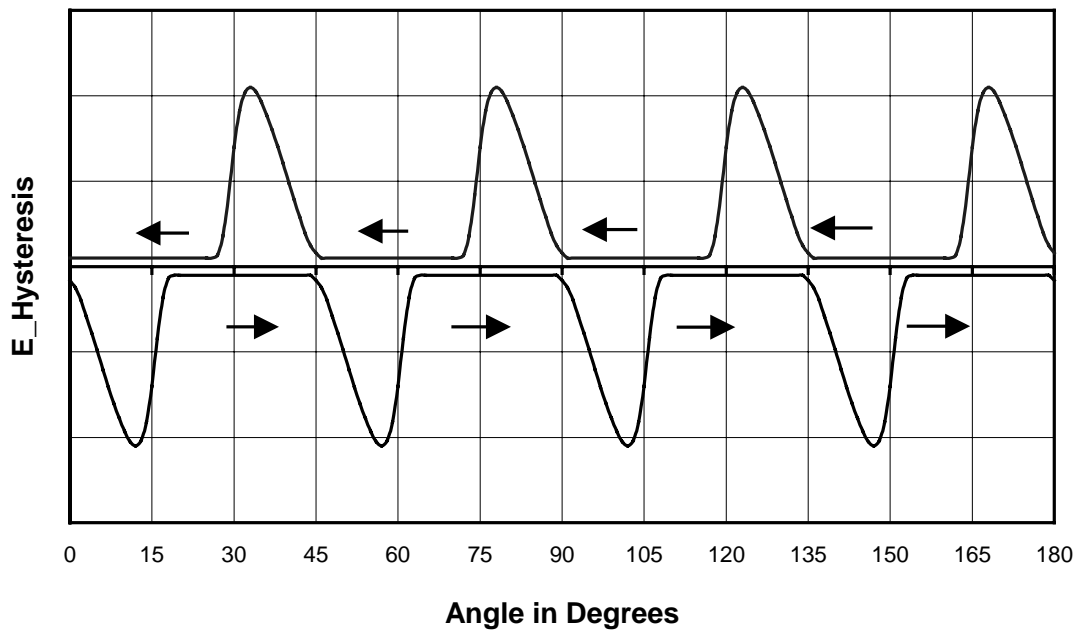

Figure 25: Shape of the measurement error caused by hysteresis

It is obvious that the measurement error caused by signal form errors and hysteresis can be neglected when using a magnetic field around 100 kA/m.

Another argument for using strong magnetic fields is the lower impact of external magnetic fields. This is especially an issue when using an unshielded magnet set-up. Here, even the very small magnetic earth field of about 30 A/m causes measurement errors. To give a rough estimation, an earth field perpendicular to the measurement field of 100 kA/m would cause a maximum error of 0.017°. Ten times this error would occur when operating at 10 kA/m, and this is not negligible.

## 7.1.2 Effects of Inhomogeneous Magnetic Fields

The sensor signal will get deformed even if sensor and magnet are not precisely aligned, which also may cause measurement errors. The reason for these deformations is that then the sensitive part of the sensor is not completely placed in the homogeneous part of the magnetic field, or, in other words, the relevant part of the magnetic field used for measurements has become inhomogeneous. As the actual angular error resulting from an inhomogeneous field depends on the specific set-up, it can not be calculated in general. However, for the simple block magnet arrangement discussed before, a rule of thumb can be used.

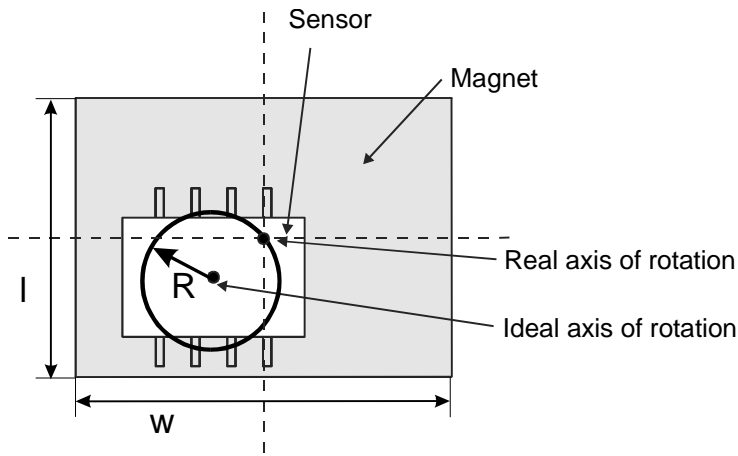

Figure 26: Definition of parameters for calculating the angular error caused by an inhomogeneous field.

Assuming the magnet arrangement depicted in Figure 2, the resulting maximum angular error can be estimated as given in Equation (10):

$$E_{\text{Inhomogeneous}} = C \cdot R^2 \quad (13)$$

## Contactless Angle Measurement using KMZ41 and UZZ9000

Application  
Note AN98097

with:	$C = \frac{320^\circ}{(w+l)^2}$	Magnet Constant
	$R$	Radius of the circle in which the centre of the magnet lies (see Figure 26). The midpoint of this circle is identical with the ideal axis of rotation
	$w$	Width of the magnet
	$l$	Length of the magnet

Note that  $w$  and  $l$  describe the magnet surface faced to the sensor. For the above mentioned magnets (see Figure 9),  $w$  and  $l$  are approximately 8 mm and thus  $C \approx 1.25^\circ / \text{mm}^2$ . Consequently, a radius  $R$  of 1 mm (the magnet is positioned 1 mm apart from the ideal position) can cause maximum errors up to  $1.25^\circ$ . As a result, small mounting tolerances are strongly recommended when using a simple block magnet arrangement. However, enlarging the magnet will reduce this error at the expense of higher magnet costs.

Please note that this error calculation is only applicable for the block magnet arrangement. When looking at more complex magnetic designs, e.g. the one depicted in Figure 10, a customised solution must be found. Normally, when carefully designing such a complex magnetic circuit, higher mounting tolerances are possible.

Also a non-parallel position of the sensor surface and magnet surface causes errors due to an inhomogeneous magnetic field in the sensitive area of the sensor. But as long as this deviation can be limited to the range of  $1^\circ$  to  $2^\circ$ , the resulting measurement error is negligible. Consequently, the achievable precision regarding parallel mounting should not be a limiting factor.

### 7.1.3 Non-Ideal Properties of the Components

Due to production scatter, the KMZ41 does not generate ideal output signals but shows some variations in performance. Since continuous improvement is the target of this sensor, please refer to the latest data sheet of the KMZ41 to get current data. In the following sections, the different effects and their impact on system accuracy are described in general.

#### *Offset and Offset Drift*

The sinusoidal output signals of the KMZ41 may show offsets that limit the accuracy of the system. From the application point of view, the offset of each channel can be subdivided into two parts: a constant portion, which is virtually eliminated by trimming, and a portion that changes with temperature but needs no compensation because it is very small. Note that the temperature dependent portion is zero at the temperature where the sensor system was trimmed. Introducing an offset into the mathematical description of both signals gives:

$$X = X_0 \sin 2\alpha + \Delta x \quad (14)$$

$$Y = Y_0 \cos 2\alpha + \Delta y \quad (15)$$

The absolute angular error caused by offsets is also a function of the actual angle. It is calculated as follows:

$$E_{Offset}(\alpha, \Delta x, \Delta y) = \left| \alpha - \frac{1}{2} \arctan \left( \frac{X_0 \sin 2\alpha + \Delta x}{Y_0 \cos 2\alpha + \Delta y} \right) \right| \quad (16)$$

If both channels have the same offsets ( $\Delta x = \Delta y$ ), the maximum angular error is:

$$E_{Offset\_Max} = 0.4^\circ / \% \text{ Amplitude} \quad (17)$$

This means that an offset of 1% referred to the amplitude ( $X_0 / \Delta x = Y_0 / \Delta y = 1\%$ ) results in a maximum angular error of  $0.4^\circ$ . Please note that both signal amplitude and offset vary with temperature. Please also note that the angular positions where these maximum errors occur are not fixed but depend on the constellation of  $\Delta x$  to  $\Delta y$ . As these values change from part to part, locations with less errors can not be determined in general.

If only one channel shows an offset but the other is ideal, the worst case value of Equation (14) is reduced by the factor  $1/\sqrt{2}$ .

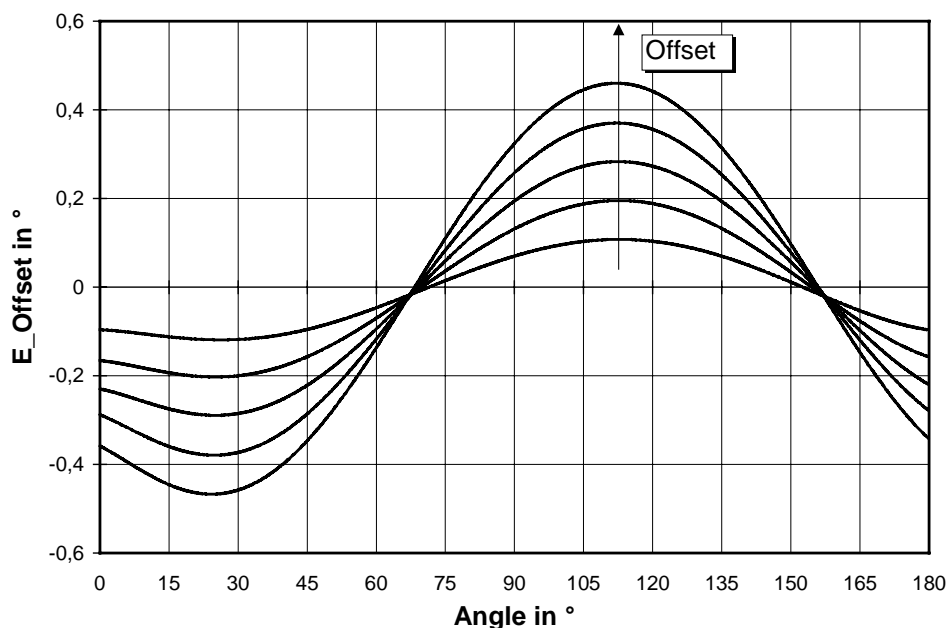

Figure 27: Typical shape of the error curve caused by signal offsets

Figure 27 shows the typical shape of the measurement error over the entire angular range. The error curve has a period of 180° what makes it distinguishable from other error shapes discussed below.

### *Different Signal Amplitudes*

Although processed at the same time and on the same silicon substrate, both Wheatstone bridges may show slightly different signal amplitudes. The angular error caused by this effect is as follows:

$$E_{\text{Amplitude}}(\alpha, A) = \left| \alpha - \frac{1}{2} \arctan \left( A \frac{\sin 2\alpha}{\cos 2\alpha} \right) \right| \quad (18)$$

with:  $A = \frac{X_0}{Y_0}$  Ratio of the signal amplitudes

The maximum error due to differences of signal amplitudes is:

$$E_{\text{Amplitude\_max}} = 0.158^\circ / \% \quad (19)$$

This means that differences between the signal amplitudes of 1% will cause a maximum angular error of 0.158°. In contrast to the offset errors, this error function shows a period of 90°. Moreover, the positions where maximum errors occur will not change significantly with A. Figure 28 shows the typical shape of the output curve.

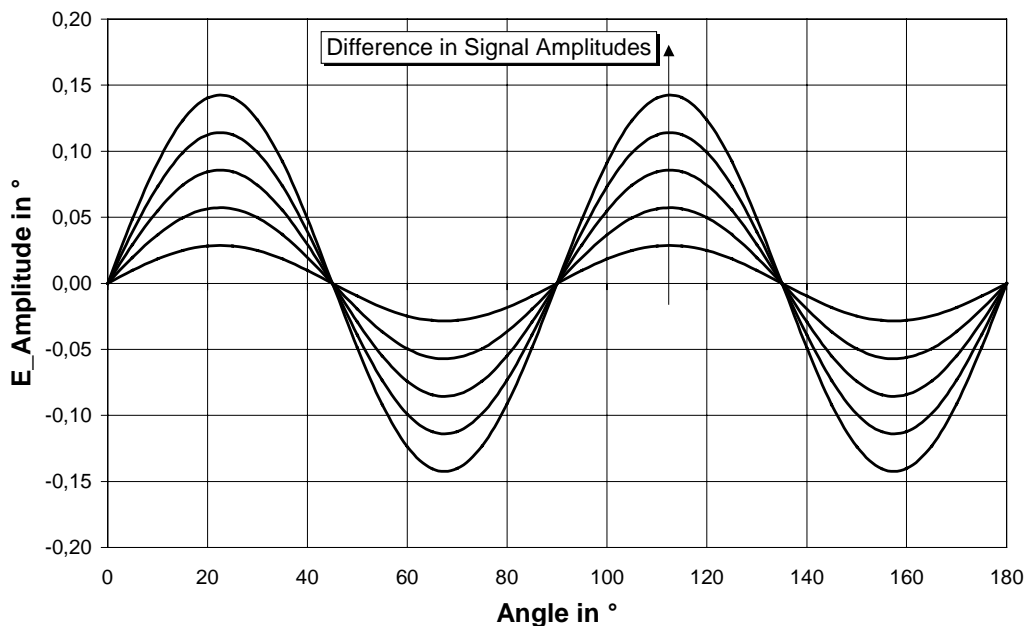

Figure 28: Typical shape of the error curve caused by different signal amplitudes.

## Phase Difference between Channels

The last item to be thought of is a phase error between both channels. This means that the phase between signal  $X$  and  $Y$  is not exactly  $90^\circ$  over the entire angular range. Introducing this error into the mathematical description of the signal gives:

$$X = X_0 \sin(2\alpha + \Delta\beta(\alpha)) \quad (20)$$

$$Y = Y_0 \cos 2\alpha \quad (21)$$

Note that the phase shift is a function of the actual angle  $\alpha$  and therefore may not be constant over the entire angular range. The resulting angular error can be calculated as follows:

$$E_{Phase}(\alpha, \Delta\beta) = \left| \alpha - \frac{1}{2} \arctan \left( \frac{\sin(2\alpha + \Delta\beta(\alpha))}{\cos 2\alpha} \right) \right| \quad (22)$$

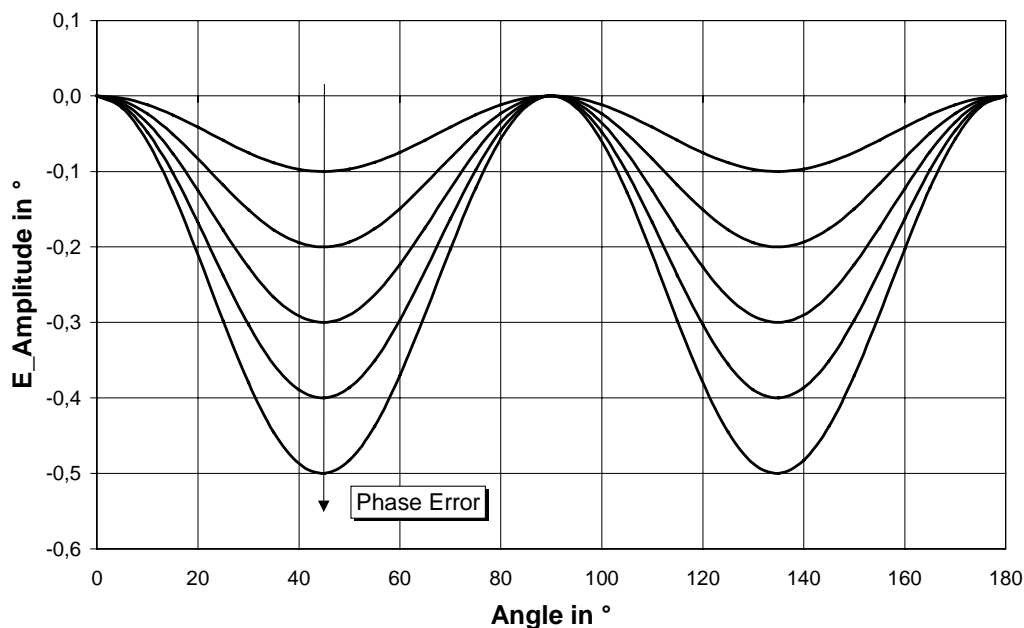

Figure 29: Typical shape of an error curve caused by phase errors.

Assuming a constant phase error, the maximum measurement error that may occur is:

$$E_{Phase\_Max} = 0.5^\circ / ^\circ \text{ Phase Shift} \quad (23)$$

This means that a phase shift of 1° results in a maximum angular error of 0.5°. Figure 29 shows the shape of the corresponding error function.

#### 7.1.4 Discussion of Different Effects

When looking at the different effects discussed before, it makes sense to distinguish between errors that can be omitted when carefully designing a system and others to which the designer has no control.

The errors caused by insufficient magnetic fields are negligible when using a suitable magnet system. Therefore they must only be included in the error budget, if weaker magnets should be used in order to reduce costs. The same argumentation holds with respect to the mechanical mounting tolerances. If accuracy is important, the magnet system can be designed to provide a larger homogeneous area, allowing mounting tolerances without any impact on system accuracy. In turn, when a simple block magnet is used, mounting tolerances can be limited to reasonable values of, for example, 0.1 mm eccentricity or less.

Consequently, only errors caused by offset, different signal amplitudes and phase shift between the two channels should be taken into account. As process scatters cause these errors, it is adequate to use a statistical calculation of the overall error for the KMZ41. This can be formulated mathematically as given in Equation (24):

$$E_{KMZ41\_Max} = \sqrt{E_{Offset\_Max}^2 + E_{Amplitude\_Max}^2 + E_{Phase\_Max}^2} \quad (24)$$

In order to get the overall error for the measurement system the errors caused by the UZZ9000 have to be added to this value.

## 7.2 Signal Conditioning IC UZZ9000

There are several blocks in the UZZ9000 that may cause errors, e.g. the ADC, the ALU and the DAC. These errors should not be discussed in detail. An analysis shows that the accuracy of the UZZ9000 is better than 0.45° in any case. This value holds over the entire specified temperature range and at all angular ranges provided.

$$E_{Signal\_Max} < 0.45^\circ \quad (25)$$

This worst case value is true for the 180° angular range of the UZZ9000. In smaller angular ranges, however, the absolute error caused by the DAC becomes smaller because then the whole output voltage range is matched to that smaller range. But as this does not significantly reduce the overall

error of the UZZ9000, for simplicity, the worst case value should be used for error calculations to be on the safe side.

Additionally, the accuracy and stability of the trimming voltage has to be taken into account. An estimate of the remaining offset error after trimming can be determined according to the following procedure (compare with section 5.4):

1. Determine the maximum voltage error of the resistor divider used for offset compensation with temperature and over lifetime according to Equation (12).
2. Determine the achievable accuracy with the trimming equipment according to Equation (11).
3. Add both values to get the remaining offset.

*Example:*

Assume that the resistor divider guarantees an accuracy better than 0.2 % VDDA with temperature and over lifetime (compare with Table 10). This means that the maximum offset voltage due to this effect would be less than 0.12 mV at 5V supply voltage (see Equation (12)).

Moreover, the measurement and trimming equipment may guarantee a duty cycle between 49.96% and 50.04%. According to Equation (11), the remaining offset voltage would be less than 0.1 mV at 5V supply voltage. Consequently, the DC offset voltage caused by non-ideal trimming is:

$$U_{Offset\_Trim} = 0.12 \text{ mV} + 0.1 \text{ mV} = 0.22 \text{ mV} \quad (26)$$

This resulting angular error  $E_{Trim}$  has to be added to the value resulting from offset drift of the KMZ41. Consequently, the overall error budget for the UZZ9000 is:

$$E_{UZZ9000\_Max} = \sqrt{E_{Signal\_Max}^2 + E_{Trim}^2} \quad (27)$$

### 7.3 Application Example for Error Calculation

The following example serves to demonstrate a way to calculate the minimum accuracy that can be expected from a MR based measurement system under certain system constraints. The component specific data are taken from the current specification of the KMZ41 and UZZ9000 (see references (1) and (2)). As these devices are targets to continuous improvement, please refer to the latest data sheets to get data presently valid.

The system data assumed and the component data used are as follows:



## Contactless Angle Measurement using KMZ41 and UZZ9000

## Application Note AN98097

• Temperature range required for the system:	-40°C to 85°C
• Temperature while trimming:	25°C
• Maximum phase error between channels:	0.5°
• Maximum error of amplitude synchronism (k):	0.5 %
• Offset Drift (TCV <sub>offset</sub> ):	2 μV / V / K
• Constant offset due to non-ideal trimming:	0.2 mV
• Supply voltage:	5 V
• Signal amplitude KMZ41:	78 mV @ 25°C
• Temperature coefficient of peak voltage (TCV <sub>peak</sub> ):	-0.31 % / K

The temperature during trimming is 25°C and therefore lies in the middle of the required operating temperature range. Consequently, the maximum change of temperature referred to this trimming temperature is about 60°C.

Nevertheless the upper limit of the operating temperature range of 85°C is more critical because the signal amplitude decreases with higher temperatures and therefore the percentage of offset to be taken into account increases. With the given data, the maximum offset voltage at 85°C is:

$$U_{\text{Offset\_Max}} = 2 \mu\text{V/V/}^\circ\text{C} \cdot 5\text{V} \cdot 60^\circ\text{C} = 0.60 \text{ mV} \quad (28)$$

The amplitude of the signal at 85°C is 63.5 mV which is calculated using Equation (6) (TCV<sub>peak</sub> = -0.31 % / K). As a result, the maximum offset caused by offset drift is:

$$\text{Offset}_{\text{Max}} = \frac{0.60 \text{ mV}}{63.5 \text{ mV}} 100\% = 0.94\% \quad (29)$$

The graph in Figure 30 shows the results of this calculation at other temperatures. For example, the offset drift to be taken into account at 125°C would be 1.7 %. At the maximum temperature of 150°C, 2.6 % offset may occur.

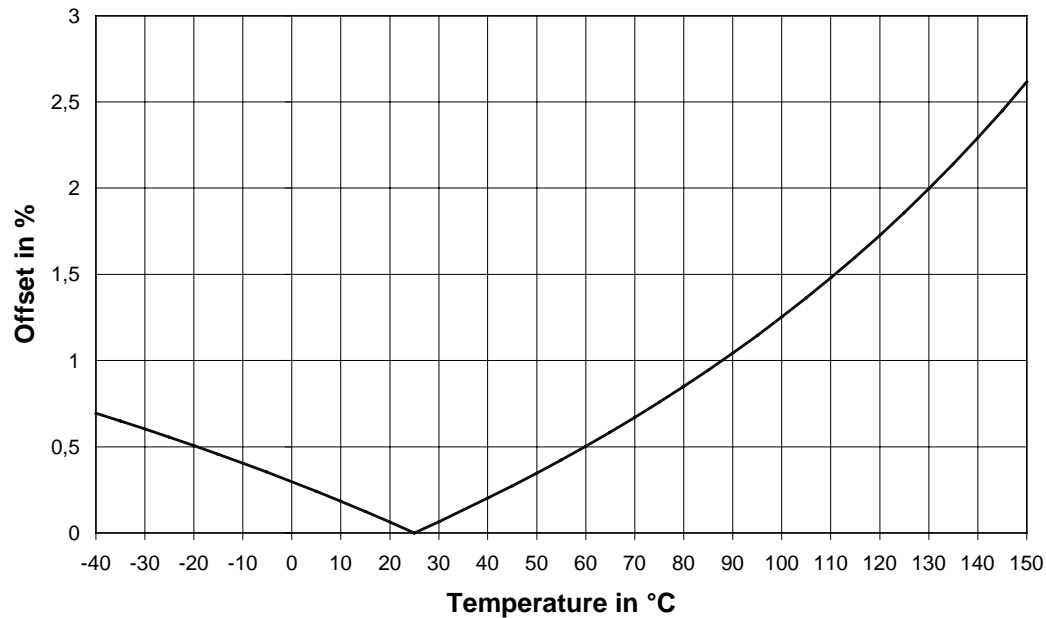

Figure 30: Offset drift at different maximum temperatures assuming the data defined in the text.

The maximum angular error caused by this offset drift can be calculated according to Equation (17). An offset of 0.94% corresponds to a maximum angular error of

$$E_{\text{Offset\_Max}} = 0.94\% \cdot 0.4^\circ / \% = 0.38^\circ . \quad (30)$$

In addition to offset drift, the trim error adds another portion. With the given remaining offset voltage of 0.2 mV after trimming, the evaluation of Equation (17) and Equation (29) results in:

$$E_{\text{Trim}} = \frac{0.2 \text{ mV}}{63.5 \text{ mV}} \cdot 0.4^\circ / \% = 0.13^\circ \quad (31)$$

Similarly, the maximum phase error and the maximum amplitude error can be calculated according to Equation (19) and Equation (23). The results are:

$$E_{\text{Amplitude\_Max}} = 0.5 \% \cdot 0.158^\circ / \% = 0.08^\circ \quad (32)$$

$$E_{\text{Phase\_Max}} = 0.5^\circ \cdot 0.5^\circ / ^\circ = 0.25^\circ \quad (33)$$

This gives an overall error of

$$\begin{aligned}
 E_{Max} &= \sqrt{E_{Offset\_Max}^2 + E_{Trim}^2 + E_{Phase\_Max}^2 + E_{Amplitude\_Max}^2 + E_{Signal\_Max}^2} \\
 &= \sqrt{0.38^2 + 0.13^2 + 0.25^2 + 0.08^2 + 0.45^2} \text{ }^\circ = 0.66^\circ
 \end{aligned}
 \tag{34}$$

As a result, an accuracy better than  $0.7^\circ$  can be expected under the given constraints.

Please note that due to the input of 3-Sigma values, this result is a 3-Sigma value also and thus typical accuracy will be significantly higher than calculated here. When using the  $180^\circ$  angular range, the relative error would be less than 0.4 %.

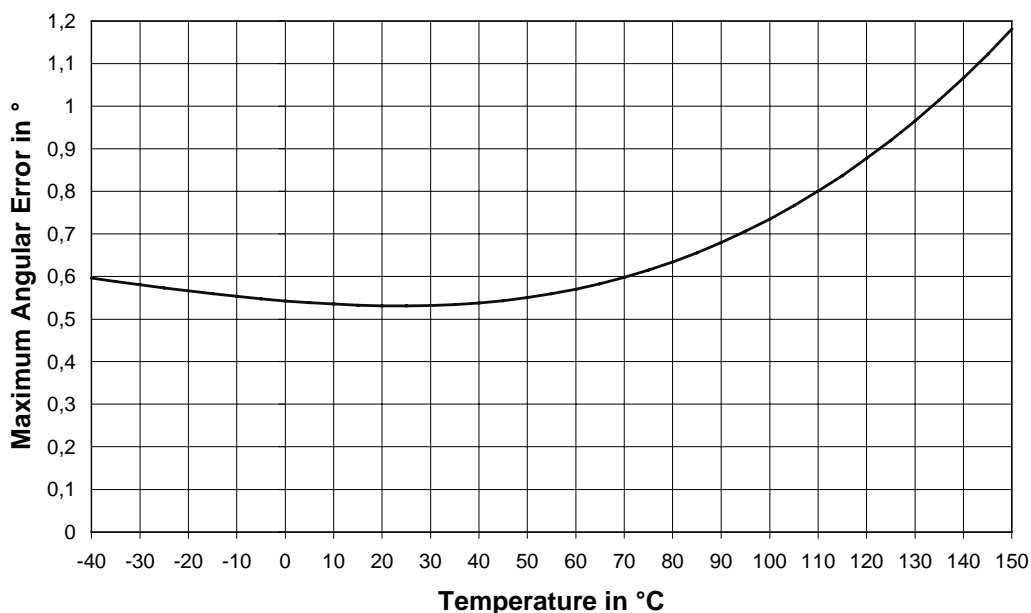

Figure 31: Maximum absolute angular error over temperature assuming the system data given in the example described in the text. The graph shows 3-Sigma values.

Similar calculations can be carried out for other temperature ranges. The result is shown in Figure 31. At  $150^\circ\text{C}$ , for example, a maximum error of  $1.2^\circ$  may occur. Again, this is a 3-Sigma value and therefore typical accuracy would be much better than calculated here.

## **8. REFERENCES**

- [1] KMZ41, Tentative Specification, Philips Semiconductors, August 1998
- [2] UZZ9000 Sensor Conditioning Electronics, Objective Specification, Data Sheet, File under Discrete Semiconductors Data Book, SC17, Philips Semiconductors, 1998-08-20
- [3] G. C. Giels: A 540 MHz 10-bit Polar to Cartesian Converter. IEEE Journal of Solid-States Circuits, Vol. 26, No 11, Nov. 1991, pp. 1645-1650.
- [4] E. v. d. Zwan: Low Power CMOS Sigma-Delta A/D converters for speech coding. Philips Research, Nat. Lab. Technical Note NR. 230/95, 1995
- [5] E. Hogenauer: An Economical Class of Digital Filters for Decimation and interpolation. IEEE Trans ASSP-29, No.2, April 1981, pp. 155-162